

HDR



AK-HVF100

AK-HBU500



AK-HC5000



AK-UCU500



AK-HRP1010



AK-HRP1015



AK-HRP250

Superior usability for HD video production at 720p, 1080i or 1080p with high speed shooting capability and 24p production

AK-HC5000 HD Studio Camera allows for superior 1080p video & 4x high-speed shooting for vivid imaging for capturing exciting moments in sports and events.



AK-HC5000

HD Studio Camera

AK-HC5000GJ (Tajimi connector model)
AK-HC5000GSJ (LEMO connector model)

HDR



* Lens and viewfinder are optional.

The state-of-the-art 3MOS sensors from constantly evolving EFP/ENG production camcorders are now available in a studio camera

1080p 4x high-speed shooting included as standard function*¹

The AK-HC5000 camera system has a high-speed shooting function that adds rich expressions to video content production. High speed shooting at up to 240 fps is achieved with four interleaved 1080p 3G SDI outputs, compatible with leading slow motion playback servers.



* Image is simulated.

Newly developed 2/3-type MOS sensor

High-image-quality video production is realized with the newly developed 2/3-type MOS sensor. (See below chart for the supported video format.)

List of supported formats*²

HD	(3G-SDI)	1080/59.94p, 50p, 59.94i, 50i, 23.98p over 59.94i, 29.97PsF, 25PsF, 23.98PsF, 720/59.94p, 50p
	High-Speed(3G-SDI x 4)	1080/239.76p, 200p, 239.76i, 200i
SD		480/59.94i, 576/50i

*1: To obtain the 1/4 slow effect, a device to separately record 1080/239.76p, 200p is necessary.
*2: AK-UCU500 Camera Control Unit (CCU) outputs 4x HD/HD/SD video.

Control via serial or IP mode

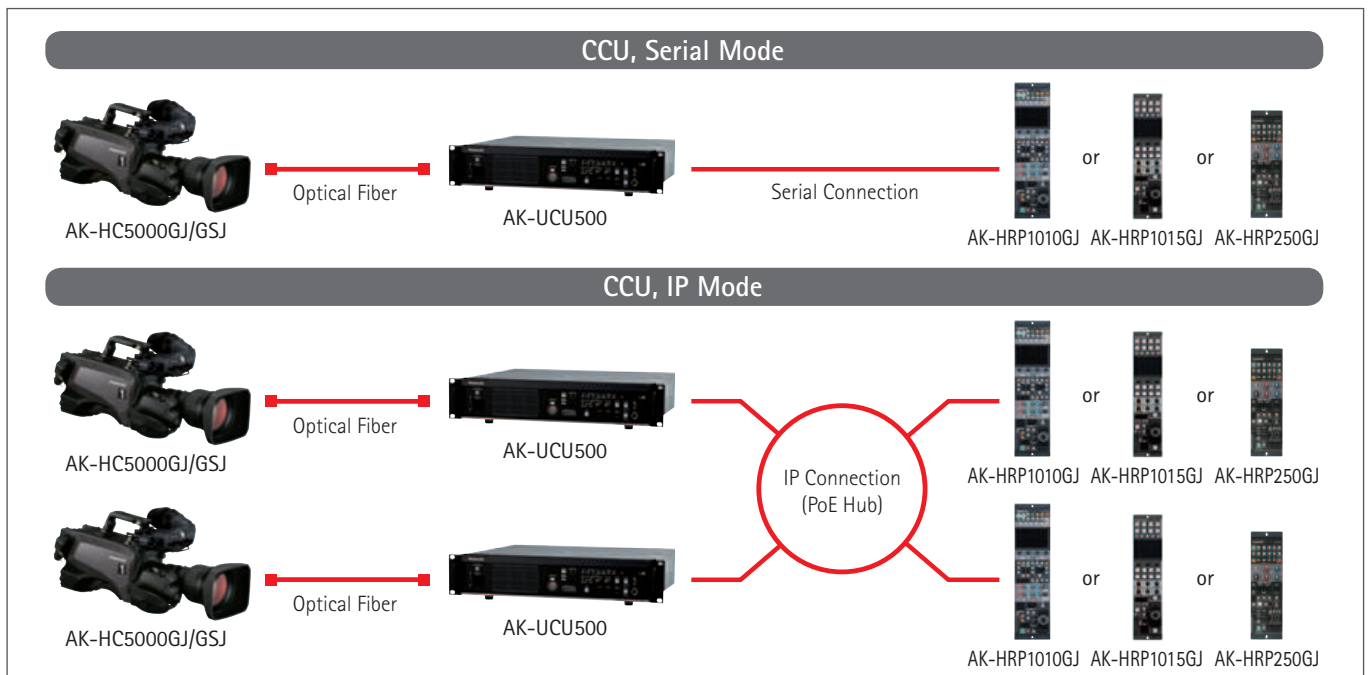

AK-HC5000 Key Features

High-quality video and excellent operability

With the AK-UCU500 Camera Control Unit (CCU), uncompressed long-distance transmission of HD video signals via optical fiber is supported. The AK-HRP1010GJ/HRP1015GJ Remote Operation Panels (ROP) are equipped with high-visibility color LCD displays. In addition, the display on the AK-HRP1010GJ is a color LCD touch panel. In combination, this system achieves high-quality video and excellent operability. In cases where power is supplied by the CCU, it is possible to transmit at a long distance of up to approx. 2,000 m between the camera and the CCU. The distance can be extended up to 10,000 m^{*1} by providing a local power supply at the camera head and using general-purpose single mode optical fiber. Between the CCU and the ROP, in addition to a dedicated serial line, IP connection via LAN cable is also supported.

High sensitivity and low noise

The AK-HC5000 is equipped with a 2/3-type 3MOS sensor, and it also has two shooting modes to choose from. In High Sense Mode, it achieves F10 59.94p and F11 50p high sensitivity and low noise with an S/N ratio of 60 dB or higher.

Skew reduction realized through high-speed scans

Building on the knowhow accumulated in Panasonic's ENG camera experience, the skewing characteristic of MOS sensors has been reduced by reading out the MOS sensor signal at high speed.

Skew reduction images



* Images are simulated.

Chromatic Aberration Compensation (CAC)

This exclusive technology utilizes communication between the lens and camera to deploy for a sophisticated algorithm that will automatically compensate for the registration error caused by lens chromatic aberration, and minimize the circumjacent blur.^{*2}

Images showing CAC (Chromatic Aberration Compensation) function effect



* Images are simulated.

Dynamic Range Stretch (DRS) function

The DRS function automatically suppresses blocked shadows and blown highlights. When dark and bright areas are mixed in the same scene, such as when looking outside from indoors, DRS can maintain a high level of gradation expression in dark, bright, and intermediate tones, thereby minimizing blocked shadows, blown highlights, and washed out colors. This makes it possible to obtain visually wide dynamic range video in real time.

Images showing DRS (Dynamic Range Stretch) effect

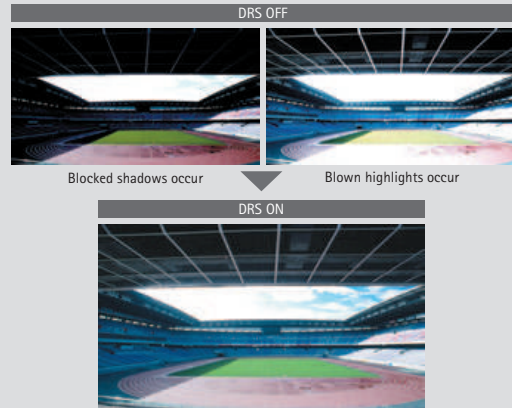

* Images are simulated.

Selectable gamma curves

In addition to the Film Rec Gamma functions (V-REC, F-REC) supporting digital film production, you can select the Filmlike 1/2/3 modes. They produce natural gradations and rich color reproduction with a film-like quality.

HDR (High Dynamic Range) compatibility HDR

This mode enables the camera to apply an alternative optical electro transfer function (OETF) to selected camera outputs so that the camera can provide a high dynamic range (HDR) image for capable displays or function in a complete HDR live broadcast system. HDR displays use their increased brightness and contrast capabilities to take advantage of the camera's full dynamic range to deliver compelling high contrast images with very bright highlights.

Shockless gain

It is possible to smoothly transition the image changes that occur when gain is changed. In addition, with the 0.1 dB step master gain adjustment function, you can fine tune the adjustments to match the scene being shot.

Diverse color correction functions

In addition to EBU and NTSC preset color matrix, camera users can save two custom specified linear matrix tables, and additionally tune the saturation and hue individual colors with 12-pole color correction system. Specific skin tones can also be adjusted in addition to the primary secondary and tertiary colors in the 12-pole system.

Skin Tone Detail Correction

Tone down wrinkles and blemishes in on air personalities to beautifully shoot natural skin tones. While designed to soften skin tones the skin tone detail feature can be applied to any hue phase so it could likewise be used to soften areas of other colors (such as green grass). The skin tone detail feature can define three independent skin tone ranges to manage different light levels or different people on camera. Skin-tone-get feature finds a specific color in frame to simplify the set up process.

Images showing Skin Tone Detail Correction effect



* Images are simulated.

*1: Adverse conditions, additional patching and longer runs will require repeater devices. *2: For software supporting Chromatic Aberration Compensation (CAC) file, please download from "Software download" on Panasonic website: <https://pro-av.panasonic.net/en/>

Servo control ND/CC filters

The cameras are equipped with filters for a variety of shooting environments.
 [ND filters] CAP, Through, 1/4, 1/16, 1/64
 [CC filters] Cross, 3200 K, 4300 K, 6300 K, Diffusion

Focus assist functions

Quick and accurate focusing is supported with focus assist functions such as Focus Bar (indicates focus level), Focus-in-Red (uses color to indicate areas in focus), MAG (magnifies central portion), and Square (shows focus status of screen as a whole). Lenses with auto focus and focus assist capabilities are also supported*1.

Focus assist function examples

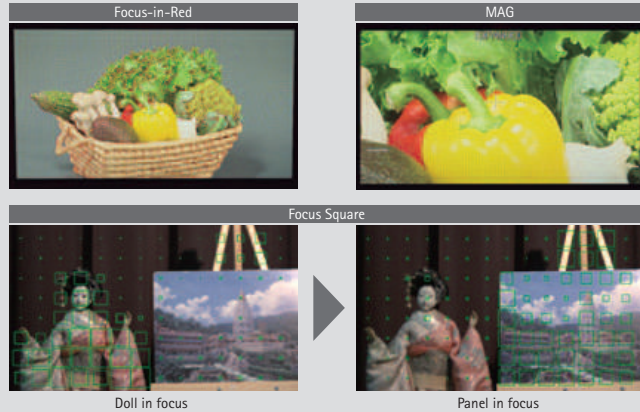

Camera standalone output formats

For camera head output (HD SDI 1/HD SDI 2), it is possible to select 1080p, 1080i, and 720p.

Extensive video and data transmission (TRUNK) functions

Since video and data can be transmitted between the camera and a Camera Control Unit (CCU) using optical fiber cable alone, system expansion to match operation conditions is possible.

- HD SDI (CCU→camera) two lines, VBS (CCU→camera) two lines: Can be used for monitoring with prompter, fixed return or camera (studio floor monitor), etc.
- HD SDI (camera→CCU) one line*2: This line can be used to transmit an additional video signal of a handheld or remote camera to the studio. Since the camera video input is equipped with a frame synchronizer, asynchronous video signals can also be used.
- LAN (1000BaseT)*2 one line: To be used to control external devices and remote cameras by IP protocol. Transmission of streaming video is also supported.
- DATA (RS422A or RS232C) two lines: Can be used to transfer lens and pedestal position data in a virtual system.

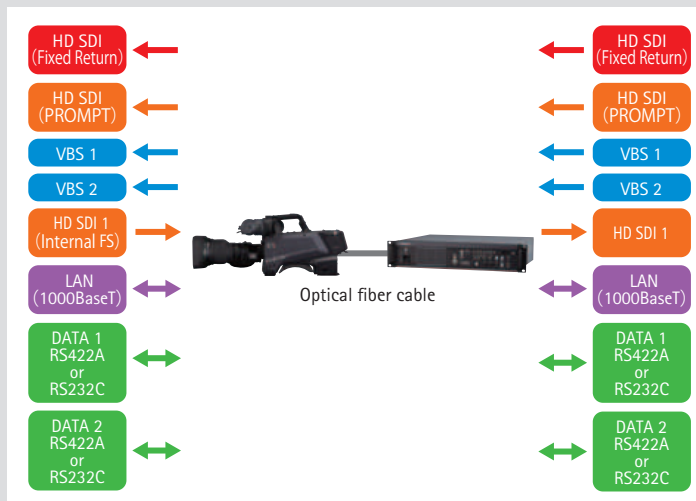

Detailed settings and functions optimized for operability

- Color temperature display and adjustment function (2000 K to 15000 K variable).
- Transmission of up to 10,000 m possible using single fiber.*3
- It is possible to save camera settings, such as video adjustments, on an SD memory card. Firmware version upgrades are also supported.
- A lens file function to save flare and shading values.
- Support for IP streaming and IP control.
- DC12 V 2.5 A and 1.0 A output as a standard feature. This can be used as a power source for large lenses, prompters, and sub-monitors.
- There are four user buttons (enabling function selection) on the camera head and four on the viewfinder. They support rapid shooting by the camera operator.

Intercom connection

With two independent intercom lines, in addition to Intercom 1 and Intercom 2 switching, an Intercom 1 and 2 mix mode has been added and can be selected to observe the situation. With the Intercom front/rear switch and front volume, it is possible to adjust the intercom audio level even when the camera is being used from the shoulder.

Intercom Operation Panel



New slanted-line design improves mobility and operability

The functional layout of controls improves ease of use and operator performance. The low profile body design, along with the low center of gravity, enhances right side visibility and comfort for the operator. The shoulder pad can be in a 24 mm range so you can increase shooting stability by adjusting the balance when lens weight changes.



*1: For the compatible lenses, please contact the manufacturer.

*2: Cannot be utilized when the camera system is HD high-speed mode is used.

*3: Adverse conditions, additional patching and longer runs will require repeater devices.

Camera System

AK-UCU500

Camera Control Unit (CCU)

AK-UCU500PJ/AK-UCU500EJ (Tajimi connector model)
AK-UCU500PSJ/AK-UCU500ESJ (LEMO connector model)

Standard high-speed output and 1080p 4x high-speed output can be selected simultaneously.



Rear View



- Optical fiber transmission of uncompressed video signals over a distance of approx. 2,000 m between camera and CCU*1.
- The compact, lightweight unit measures 2U in height and is rack-mountable.
- Supported formats
HD (3G-SDI) : 1080/59.94p, 50p, 59.94i, 50i, 23.98p over 59.94i, 29.97PsF, 25PsF, 23.98PsF, 720/59.94p, 50p
HD High Speed(3G-SDI x 4)*2 : 1080/239.76p, 200p, 239.76i, 200i
SD : 480/59.94i, 576/50i
- Supports IP streaming (100 Base-T).
- SD memory card can be used for saving user files and updating firmware versions.
- Input/output
SDI OUT x 7, SDI OUT (PM) x 1, VBS x 1, etc.
*HS MODE*2 : SDI OUT x 4 (HS), SDI OUT x 3, SDI OUT (PM) x 1, VBS x 1, VBS (PM) x 1
RET Input (SDI: 4ch, VBS: 1ch) etc.
LAN-TRUNK (100/1000BASE-T)
PROMPT Input (SDI : 1ch, ANALOG : 2ch)

*1: When power is supplied from CCU.
*2: When Connected with AK-HC5000 HD Studio Camera.
*3: Abbreviation of Power over Ethernet.

AK-HRP1010GJ

AK-HRP1015GJ

AK-HRP250GJ

Remote Operation Panel (ROP)

Expand operation scope with three size options: a full operation panel and a simplified panel. These compact operation panels also support PoE*3 and IP control.



AK-HRP1010GJ



AK-HRP1015GJ



AK-HRP250GJ

Rear View

AK-HRP1010GJ

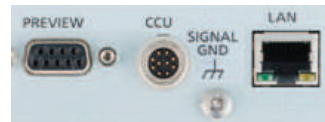

AK-HRP1015GJ/HRP250GJ



- Three models: 1/4 rack size (AK-HRP1010GJ), 1/5 rack size (AK-HRP1015GJ) and 1/4 rack size (AK-HRP250GJ)
- LCD panels with enhanced visibility.
AK-HRP1010GJ: 3.5-inch color LCD touch panel
AK-HRP1015GJ: 3.2-inch color LCD panel
- Camera serial control and IP control (RJ45 LAN cable) are possible.
- Supports PoE*3, which can supply power via LAN cable (CAT5e or faster).
- Functions for studio camera scene file registration and retrieval.
- Equipped with SD memory card slot for saving user files, scene file and updating firmware versions.

AK-HVF100GJ

22.9 cm (9 inches) LCD Color Viewfinder

Equipped with newly designed tilt mechanism and extensive functions such as focus assist and external video input.

- High-resolution 22.9 cm (9 inches) color LCD panel displays full HD 1920 x 1080 pixels
- Focus assist functions (Focus-in-Red, Focus Bar*1)
- Detail depends on zoom ratio*1
- External HD-SDI (3G SDI) input
- External DC input (+12 V DC)
- Four assignable function buttons
- Contrast, brightness, and peaking are adjustable
- Pan, tilt, and lift structure used

*1: When connected to AK-HC5000.



Rear View



AK-MSU1000GJ

Master Setup Unit (MSU)

Controls up to 99 CCU units via IP

- IP and serial connections supported.
 - IP connection: Up to 99 units
 - Serial connection: Up to six units
- 7-inch Touch Panel LCD
- Video monitoring function
- HD SDI Input (Monitoring) (1080i)
- Power DC12 V (DC10 V - DC17 V) or PoE+ (via PoE+ Hub)



Rear View



AK-HBU500GJ

Build-up Unit

Enables use of large studio-use lens.



Side Panel



Rear control panel



- Smooth camera mounting/removal possible
- Precise optical axis (horizontal/vertical) adjustment structure
- Rear control panel equivalent to that of a large camera
- DC OUT 12V 7.5 A (XLR4-pin)/DC OUT 1.5 A (4-pin)

Other accessories



AK-HVF75GJ
17.8 cm (7 inches) LCD
Color Viewfinder



AJ-CVF70GJ
1.78 cm (0.7 inches) Full HD
OLED Color Viewfinder



AJ-CVF25GJ
87.6 mm (3.45 inches)
Electronic HD Color Viewfinder



AJ-MC700P
Microphone Kit (monaural)



AW-PS551
AC Adaptor

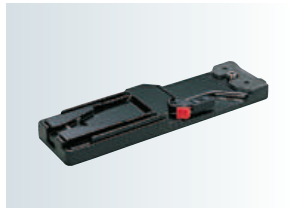

SHAN-TM700
Tripod Adapter



AJ-MH800G
Microphone Holder



AJ-C10050G
Remote Control Cable
(50 m / 164 feet)

System Configuration

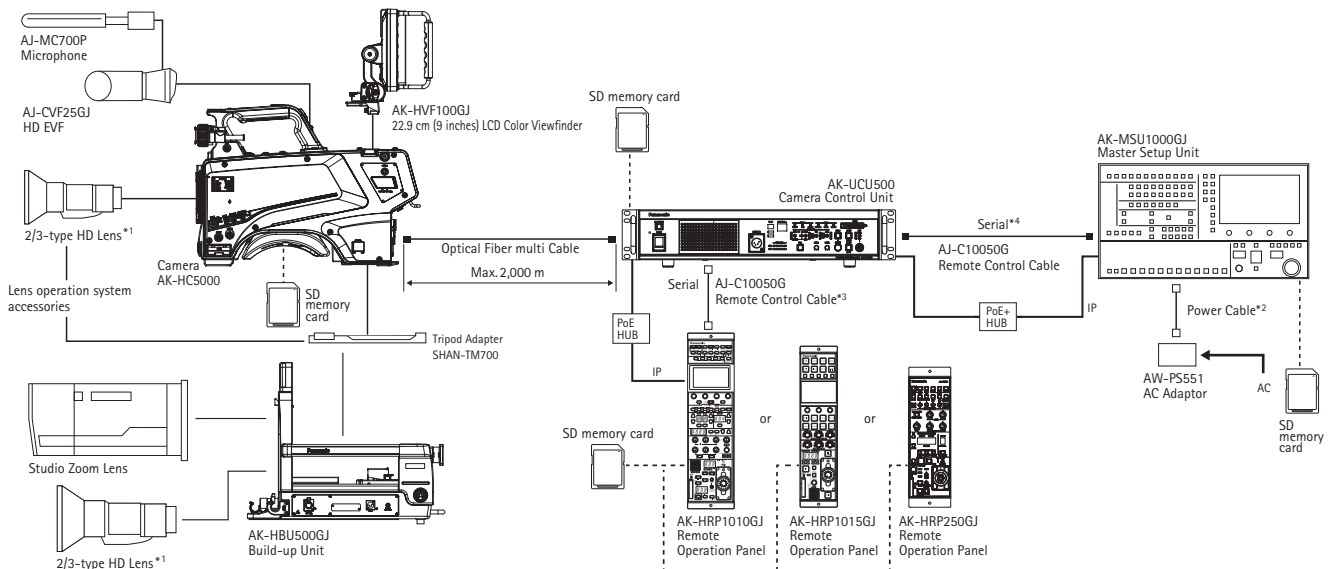

*1: For software supporting Chromatic Aberration Compensation(CAC)file, please download from "Software download" on Panasonic website: <https://pro-av.panasonic.net/en/>

*2: A power cable is included with the AC Adaptor.

*3: With the use of a serial remote control cable AJ-C10050G, power for ROP is supplied from a CCU.

*4: When AK-MSU1000 is connected to AK-UCU500 via serial cable, AW-PS551 or PoE+ HUB is required.

Specifications

As of April, 2022

AK-HC5000GJ/HC5000GSJ

Power Supply	DC 12 V (when using an external power supply) AC 240 V, 50 Hz/60 Hz (when AK-UCU500P/AK-UCU500PS/ AK-UCU500E/AK-UCU500ES is connected)
Power Consumption	119 W (maximum, when connecting to an external 12 V and including supply to an externally connected devices) 360 W (maximum, when AK-UCU500P/AK-UCU500PS/ AK-UCU500E/AK-UCU500ES is connected and including supply to an externally connected devices)
Operating Temperature	-10 °C to 45 °C (14°F to 113°F) (Preheating required under a temperature 0 °C (32 °F) or below)
Storage Temperature	-20 °C to 60 °C (-4°F to 140°F)
Operating Humidity	85% or less (relative humidity)
Weight	Approx. 4.4 kg (9.70 lbs.) (body only, excluding the accessories)
Dimensions (W x H x D)	Body only 151 mm x 267 mm x 371.5 mm (5-31/32 inches x 10-17/32 inches x 14-21/32 inches) (excluding protrusions)
Pickup Device	2/3-type, 2.2 million pixels, MOS x 3
Optical Filter	CC: 3200 K, 4300 K, 6300 K, Cross, Diffusion ND: CAP, Clear, 1/4, 1/16, 1/64
Lens mount	2/3-type bayonet
Sensitivity	Two shooting modes [HIGH SENS]: F11 (59.94 Hz)/F12 (50 Hz) [NORMAL]: F8 (59.94 Hz)/F9 (50 Hz) 2000 lx, 3200 K, when white reflectivity is 89.9%
Horizontal Resolution	1000 TV lines or above (center)
S/N	60 dB or above
Horizontal Modulation	50% or above (27.5 MHz)
Gain switching	[NORMAL]: -3, 0, 3, 6, 9, 12, 15, 18, 21, 24, 27, 30, 33, 36 [HIGH SENS]: -6, -3, 0, 3, 6, 9, 12, 15, 18, 21, 24, 27, 30, 33, 36
Shutter speed	<ul style="list-style-type: none"> •[59.94i]/[59.94p] mode: 1/100, 1/120, 1/125, 1/250, 1/500, 1/1000, 1/1500, 1/2000 •[29.97p] mode: 1/48, 1/50, 1/60, 1/96, 1/100, 1/120, 1/125, 1/250, 1/500, 1/1000, 1/1500, 1/2000 •[23.98p] mode: 1/48, 1/50, 1/60, 1/96, 1/100, 1/120, 1/125, 1/250, 1/500, 1/1000, 1/1500, 1/2000 •[50i]/[50p] mode: 1/60, 1/100, 1/125, 1/250, 1/500, 1/1000, 1/1500, 1/2000 •[25p] mode: 1/48, 1/50, 1/60, 1/96, 1/100, 1/125, 1/250, 1/500, 1/1000, 1/1500, 1/2000
<HD SDI1> terminal	BNC x 1 HD (3G/1.5G): 0.8 V [p-p], 75 Ω
<HD SDI2> terminal	BNC x 1 HD (3G/1.5G): 0.8 V [p-p], 75 Ω
<AUX> terminal	BNC x 1 Functions as <HD TRUNK> terminal/<PROMPTER2> terminal by switching the setting in the menu <HD TRUNK>: HD (1.5G) <PROMPTER2>: VBS signal 1 V [p-p], 75 Ω
<G/L IN/PROMPTER OUT> terminal	BNC x 1 <G/L IN>: Tri-level SYNC or BB (black burst) <PROMPTER OUT>: VBS signal 1 V [p-p], 75 Ω Functions as <G/L IN> when standalone, and as <PROMPTER OUT> when AK-UCU500P/ AK-UCU500PS/ AK-UCU500E/AK-UCU500ES is connected
<MIC 1> terminal	XLR x 1, 3-pin <LINE>/<MIC>/<+48 V> switchable For <MIC>, <FRONT>/<REAR> switchable <LINE>: 0 dBu, +4 dBu menu selection available <MIC>: -60 dBu, -40 dBu, or -20 dBu menu can be selected

<MIC 2> terminal	XLR x 1, 3-pin <LINE>/<MIC>/<-48V> switchable <LINE>: 0 dBu, +4 dBu menu selection available <MIC>: -60 dBu, -40 dBu, or -20 dBu menu can be selected
<MIC> terminal (front)	XLR x 1, 3-pin Switchable with <MIC 1> terminal
<INTERCOM1> terminal	XLR x 1, 5-pin
<INTERCOM2> terminal	XLR x 1, 5-pin
<EARPHONE> terminal	Stereo mini jack x 1, 3-pin
<OPT FIBER> terminal	Optical composite connector x 1
<LENS> terminal	12-pin x 1
<VF> terminal	20-pin x 1
<VF> terminal (rear)	29-pin x 1
<DC IN> terminal	XLR x 1, 4-pin, DC 12 V
<DC OUT 12 V 1 A> terminal	4-pin x 1
<RET CTRL> terminal	6-pin x 1
<EXT I/O> terminal	20-pin x 1, DC 12 V, 0.5 A
<REMOTE> terminal	10-pin x 1
<TRUNK> terminal	12-pin x
<DC OUT 12 V 2.5 A> terminal	2-pin x 1
<LAN> terminal	RJ-45 x 1
<USB2.0> terminal (host)	Type A connector, DC 5 V, 0.5 A
Build-up terminal	20-pin x 1

AK-UCU500PJ/UCU500EJ/UCU500PSJ/UCU500ESJ

Power Supply	AK-UCU500P/AK-UCU500PS: 100 V - 120 V AC, 50 Hz/60 Hz AK-UCU500EJ/AK-UCU500ES: 100 V - 240 V AC, 50 Hz/60 Hz
Power Consumption	500 W (Without camera connected: 70 W)
Capacity for Supplying Power to a Camera	240 V AC (tolerance: 5%), 1.46 A , 50 Hz/60 Hz
Operating Temperature	0°C to 40°C (32°F to 104°F)
Humidity	10% to 90% (no condensation)
Weight	Approx. 8.8 kg (19.4 lb)
Dimensions (W x H x D)	424 mm x 88 mm x 401 mm (16-5/8 inches x 3-7/16 inches x 15-13/16 inches) (excluding protrusions)
Video Output	3G/HD/SD-SDI: 7 lines (embedded audio is supported only for HD signals) HD/SD-SDI: 1 line (shared with picture monitor output*1); embedded audio is supported only for HD signals) Analog composite: 2 lines (1 line shared with picture monitor output*1)
HD TRUNK Output	HD-SDI: 1 line (cannot be used in UHD/HS mode)
Return Input	3G-HD/HD/SD-SDI: 4 lines (RET1 input has active-through output) Analog composite: 1 line
Prompter Input	HD-SDI: 1 line (with active-through output) Analog composite: 2 lines (through output of 1 and input of 2 share the connector*1) It is not terminated when the unit is turned OFF. No through output.
Reference Input	BB (black burst) / tri-level*2: 1 line (automatic termination, connect to upper connector; BB signal and tri-level signal automatically recognized, with loop-through output)
Microphone Output	0 dBm/600 Ω, 2 lines (XLR, 3-pin, male)
Communication	Intercom input/output (ENG / PROD, 0 dBm, 600 Ω (4 W) / 1 V [p-p], 200 Ω (RTS), 4 W / RTS / CLRCOM) : 2 lines*1 PGM input (0 dBm/600 Ω) : 2 lines Tally input (red, green, yellow) : 1 input each
AUX	WFM control 6-bit (open collector output, terminal shared with camera microphone gain setting*1) Camera microphone gain setting input 5-bit (photo-coupler input, terminal shared with WFM control*1) Down-conversion system setting input 2-bit (photo-coupler input)
TRUNK	RS-422 / RS-232C 2 lines*1
FRONT ROP	RS-422 1 line, 16 V DC output (only one of this and REAR ROP can be selected at one time via the menu or the [ROP FRONT/ REAR] selection switch on the front panel)

Specifications

As of April, 2022

REAR ROP	RS-422 1 line, 16 V DC output (only one of this and FRONT ROP can be selected at one time via the menu or the [ROP FRONT/REAR] selection switch on the front panel)
MSU	RS-422 1 line, GPI for control
LAN TRUNK	LAN connection with camera side via an optical cable*3 1 line, 100BASE-T, 1000BASE-T
LAN	Personal computer connection for distribution via the Web*3 1 line, 10BASE-T, 100BASE-TX (use a crossover cable when connecting directly with a personal computer)

AK-HVF100GJ

Power Supply	DC 12 V (supplied from camera or XLR)
Power Consumption	18 W
Operating Temperature	0 °C to 45 °C (32 °F to 113 °F)
Operating Humidity	10% – 85% (no condensation)
Storage Temperature	-20 °C to 60 °C (-4 °F to 140 °F)
Weight	Approx. 2.6 kg (5.73 lbs.) (not including hood) / Approx. 3.0 kg (6.61 lbs.) (including hood)
Dimensions (W x H x D)	340 mm x 234 mm x 193 mm (13-13/32 inches x 9-7/32 inches x 7-5/8 inches) (not including hood) 340 mm x 234 mm x 231 mm (13-13/32 inches x 9-7/32 inches x 9-1/8 inches) (including hood)
Display Panel	9.0 inches
Number of Pixels	1920 x 1080 (FHD)
Display Color	Approx. 16.77 million colors
Operation	<POWER> switch, <MENU> button, <SELECT> dial button, <F1>/<F2>/<F3>/<F4> buttons, <BRIGHT> knob, <CONTRAST> knob, <PEAKING> knob, <INPUT> switch
Connector	Camera I/F connector (D-sub 29 pins x 1) SDI IN connector (BNC x 1) DC IN connector (XLR 4 pins x 1)
Supported Signal Format	CAM: 1080/59.94i, 1080/50i SDI: 1080/59.94p, 1080/50p, 1080/59.94i, 1080/50i, 720/59.94p, 720/50p

AK-MSU1000GJ

Power Supply	12 V DC (DC input range: 10 V - 16 V DC) 42 V - 57 V DC (PoE+ power supply)
Power Consumption	1.6 A (Power supply: 12 V DC) 0.6 A (PoE+ power supply)
Operating Temperature	0°C to 40°C (-4°F to 140°F)
Humidity	90% or less
Storage Temperature	-20°C to 60°C (-4°F to 140°F)
Weight	Approx. 4.0 kg (8.82 lb)
Dimensions (W x H x D)	482 mm x 222 mm x 81.5 mm (18-31/32 inches x 8-3/4 inches x 3-7/32 inches) (including mounting brackets and dial heights)
Adjustment Functions	Scene file, ND filter, CC filter, Color temperature (COLOR TEMP), Master gain (MASTER GAIN), Shutter (SHUTTER), Master pedestal (MPED), Iris (IRIS), Camera selection
CCU Control	RS422 or IP
Maximum Cable Length	When CCU connected: 50 m (164 ft)

AK-HBU500GJ

Power Supply	12 V DC (when external power is supplied) 240 V AC 50 Hz/60 Hz (when AK-UCU500 is connected)
Power Consumption	70 W (when external power is supplied) 165 W (when AK-UCU500 is connected)
Operating Temperature	-10°C to 45°C (14°F to 113°F)
Operating Humidity Range	85% or less (relative humidity)
Storage Temperature	-20°C to 60°C (-4°F to 140°F)
Weight	Approx. 12.8 kg (28.22 lb) (unit only)
Dimensions (W x H x D)	300 mm x 417 mm x 510 mm (16-7/16 inches x 20-1/16 inches x 11-13/16 inches)
Camera Number Display	1 to 15 (depending on system settings)
LENS I/F Connector	36-pin x 1
CAMERA I/F Connector	20-pin x 1
[DC IN] Connector	XLR x 1, 4-pin, 12 V DC
[DC OUT 12 V 1.5 A] Connector	4-pin x 1
[DC OUT 12 V 7.5 A] Connector	XLR x 1, 4-pin

AK-HRP1010GJ/HRP1015GJ/HRP250GJ

	AK-HRP1010GJ	AK-HRP1015GJ	AK-HRP250GJ
General			
Power Supply	12 V DC (Power supply from camera/CCU: 10 V - 16 V DC) 42 V - 57 V DC (PoE power supply)	12 V DC (Power supply from camera: 10 V - 16 V DC) 42 V - 57 V DC (PoE power supply)	
Power Consumption	0.9 A (Power supply from camera/CCU: 10 V - 16 V DC) 0.3 A (PoE power supply)	0.44 A (Power supply from camera: 10 V - 16 V DC) 0.11 A (PoE power supply)	0.51 A (Power supply from camera: 10 V - 16 V DC) 0.15 A (PoE power supply)
Operating Temperature	0 °C to 40 °C (32 °F to 104 °F)		
Humidity	90% or less		
Storage Temperature	-20 °C to 60 °C (-4 °F to 140 °F)		
Weight	Approx. 1.7 kg (3.75 lb)	Approx. 1.5 kg (3.3 lb)	Approx. 1.4 kg (3.08 lb)
Dimensions (W x H x D)	102 mm x 385 mm x 113 mm (4 inches x 15-3/16 inches x 4-7/16 inches)	82 mm x 355 mm x 124.4 mm (3-1/4 inches x 14 inches x 4-7/8 inches)	92 mm x 308 mm x 67 mm (3-5/8 inches x 12-1/8 inches x 2-5/8 inches)
Camera/CCU Control	Control signals (camera, CCU control) Power supply 16 V DC (when CCU connected)*4, 12 V DC (when camera connected)*4		
Maximum Cable Length	When camera connected: 20 m (65.7 ft) When CCU connected: 50 m (164 ft)		
Monitor			
LCD Monitor	LCD color monitor, touch panel support	LCD color monitor	-
Input/Output Section			
<CCU> connector	10-pin, male x 1		
<PREVIEW> connector	9-pin, female x 1		
<LAN> connector	RJ-45 x 1	RJ-45 x 1 (equipped with a robust LAN terminal connector)	

*1: Depending on the setting, only one of them can be selected at one time. *2: The BB (black burst) signal and tri-level sync signal of the reference input are recognized automatically. *3: IP video cannot be transmitted when [CCU MODE] is set to [2160/23.98p], [2160/23.98PsF], [1080/23.98p], or [1080/23.98PsF]. *4: Can be provided from CCU

Dimensions

As of April, 2022

Unit: mm(inches)

■ AK-HC5000GJ/HC5000GSJ

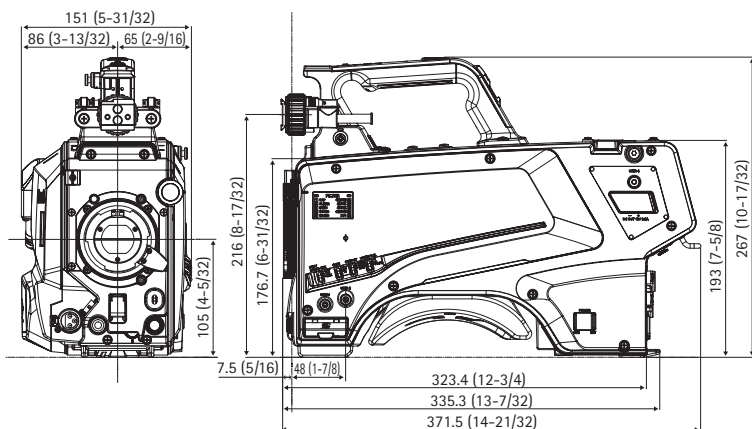

■ AK-HRP1010GJ

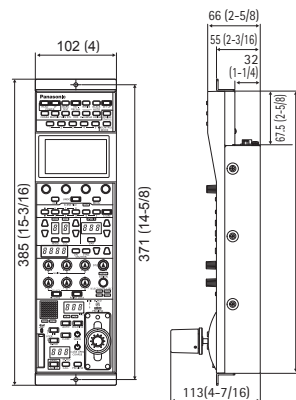

■ AK-UCU500PJ/EJ/PSJ/ESJ

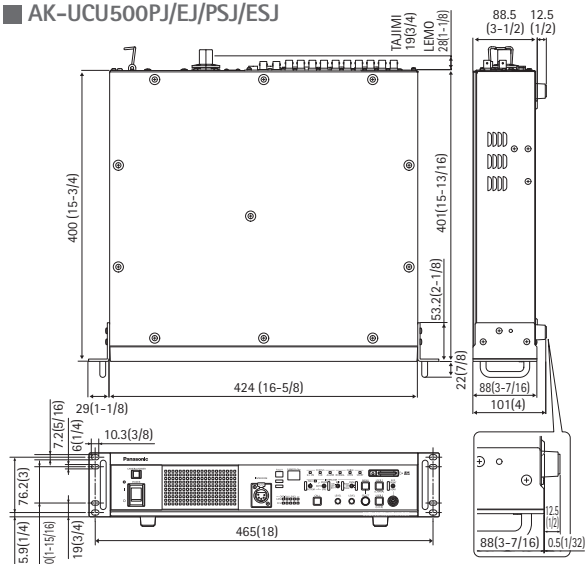

■ AK-HRP1015GJ

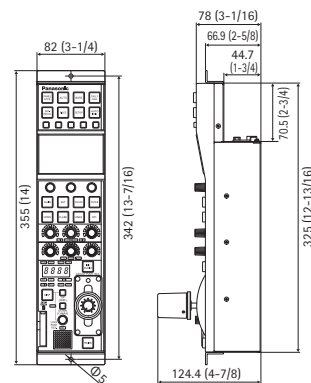

■ AK-HRP250GJ

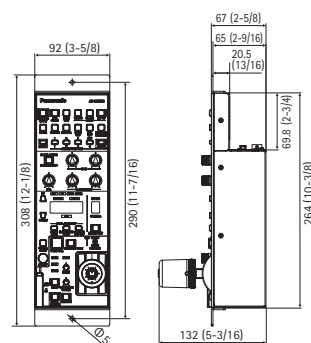

■ AK-MSU1000GJ

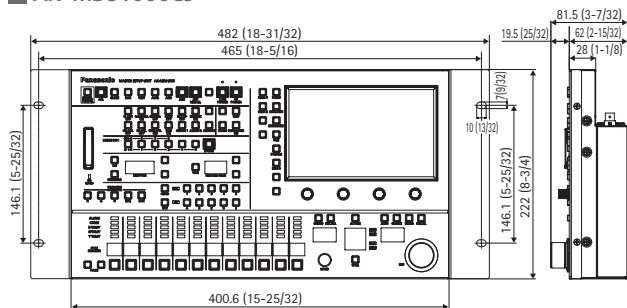

■ AK-HBU500GJ

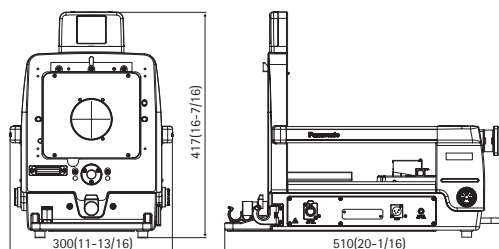

■ AK-HVF100GJ

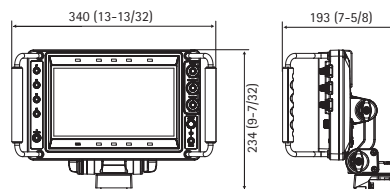



Panasonic®

Panasonic Connect Co., Ltd.
2-15 Matsuba-cho, Kadoma, Osaka 571-8503 Japan



For more information, please visit Panasonic web site
<https://pro-av.panasonic.net/en/qr/>



Factories of Panasonic Connect Co., Ltd. have received ISO14001:2015-the Environmental Management System certification. (Except for 3rd party's peripherals.)



Broadcast and Professional AV Website



Contact Information



Facebook



Mobile App