

Operating Instructions Functional Manual

Wireless Presentation System For business use

Model No.	TY-WPS1 TY-WPS1W WPS Basic Set	TY-WPB1 TY-WPB1W WPS Transmitter	TY-SB01WP Wireless Presentation System Receiver Board
	TY-WPSC1 TY-WPSC1W WPS USB-C Basic Set	TY-WP2BC1 TY-WP2BC1W WPS USB-C Transmitter Set	TY-WPR1 WPS Receiver
	TY-WP2B1 TY-WP2B1W WPS Transmitter Set	TY-WPBC1 TY-WPBC1W WPS USB-C Transmitter	* WPS is an abbreviation of "Wireless Presentation System".



PressIT

* PressIT is a nickname for "Wireless Presentation System".

Thank you for purchasing the Panasonic product.

- Please read these instructions before operating this product and retain them for future reference.
- **Be sure to read "Safety Precautions" (page 2 to 3) before use.**
- This Operating Instructions is common to all the models regardless of suffixes of the model number.

No suffix: EU, US

W: CIS, Oceania, Hong Kong

English

Safety Precautions	2
Before Using	4
Features of the system	4
Precautions for use	4
Notes on Using Wireless LAN	6
Request Regarding Security	7
Accessories	8
Part Names	9
Connection	12
Connecting the receiver	12
Connecting the transmitter	13
Installation of the receiver board	14
Basic Use	17
Single connection	17
Multi connection	18
Fixing image switching (fixed mode)	19
Setting the fixed mode	19
Canceling the fixed mode	19
Transmitter Extension Method (Pairing)	20
Pairing by connecting the receiver and transmitter	20
Pairing by saving a file to the USB memory	21
About LAN Connection	22
Using with Android device (Android 5.0 and later versions)	23
Use an app on the Android device and connect the device to the wireless LAN coming from the receiver	23
Use an app on the Android device and connect the device to the external wireless LAN	23
Setting	25
About the standby screen	25
Displaying the Web setting screen	27
Configuring various settings on the Web setting screen	30
[Setup] menu (display setting)	43
Using the HDMI-CEC function	48
Using "HDVC" on this system	51
Connecting the BQ1 touch panel	51
Installing the Receiver	52
Components for receiver mounting bracket	52
Mounting the base bracket (common)	52
Installing on the ceiling or wall	53
Installing on the display	53
Recommended example for installing on the projector professional model	55
Recommended example for installing on the projector system model	56
Recommended example for installing on the projector portable model	58
Image Signals Supported by This Product	59
Troubleshooting	60
Specifications	61
Software License	63
Trademark Credit	63
FCC STATEMENT	64

WARNING:

Stop using the product immediately when an abnormality or malfunction occurs.

Remove the power plug in the case of an abnormality.

- Smoke is emitted, or abnormal smell or sound occurs.
- Video or audio is not reproduced in some cases.
- Liquid such as water or a foreign object has entered inside the product.
- The product is deformed or damaged.

Using the product in such states may cause a fire or electric shock.

- Remove the power plug from the outlet and request repair to the dealer where you purchased the product.
- It is necessary to remove the power plug to completely turn off the power of this product.
- Do not repair the product by the customer since it is dangerous.
- Use an outlet located at a position where the hand can reach easily so that the power plug can be removed quickly.

Do not insert foreign objects into the product.

Do not insert or drop metals or flammable items into the inside the product from the vent hole, etc.

- Smoke is emitted, or abnormal smell or sound occurs.
- Keep an eye on children in particular.

■ About AC adaptor

Do not use an AC adaptor or AC adaptor cable other than those supplied with this product.

Using an AC adaptor or AC adaptor cable other than those supplied may cause an electric shock or fire due to short circuit or heat generation.

Clean the power plug periodically to prevent dust from accumulating.

Failure to do so may cause a fire or electric shock due to moisture.

- Remove the power plug and wipe it with dry cloth.

Do not insert or remove the power plug with wet hand.

Doing so may cause an electric shock.

Do not use the outlet or wiring devices exceeding rated values or with currents other than 100 – 240 V AC.

Using them exceeding rated values by connecting too many plugs in one outlet may cause a fire due to heat generation.

Insert the power plug securely to the end.

Insufficient insertion may cause a fire due to an electric shock or heat generation.

- Do not use the product with a damaged plug or loose outlet.

Do not damage the AC adaptor and power plug.

- (by damaging, modifying, forcibly bending, twisting, pulling or bundling them, bringing them close to heat appliances, placing heavy items on them, etc.)

Doing so may cause a fire or electric shock due to short circuit or disconnection.

- Request the dealer for repair of the AC adaptor or power plug.

Use the product 15 cm or more away from a location where a cardiac pacemaker is embedded.

Radio waves may affect the operation of the pacemaker.

Do not use the product in an airplane.

The operational safety may be impaired.

Do not use the product near an automatic door, fire alarm or other automatic control devices.

Radio waves from this product may affect automatic control devices, which may cause an operational error, resulting in an accident.

Do not use the product in hospital or a location with medical equipment.

Radio waves from this product may affect medical equipment, which may cause an operational error, resulting in an accident.

Do not use the product while touching it for a long time.

Touching the hot parts of the product and AC adaptor for a long time may cause a low-temperature burn*.

* Persons with poor bloodstream (due to vascular impairment, poor blood circulation, diabetes or strong compression) or poor skin sensitivity (elderly persons) tend to get a low-temperature burn.

Do not touch the product and AC adaptor if it begins to thunder.

Doing so may cause an electric shock.

Do not wet the product.

Doing so may cause a fire or electric shock.

Do not place the product on unstable locations.

Placing the product on a shaky table or an inclined location may cause an injury due to falling over or dropping.

Do not remove or modify the back cover (cabinet).

Keep the screws supplied with the receiver out of reach of infants.

The screws may be accidentally swallowed.

- In the event this occurs, consult a doctor immediately.

For installation, please ask a qualified technician or a dealer.

If installation is not carried out and secured correctly, it can cause falling accidents.

- If you terminate the use of the product, ask a professional to remove it promptly.

Do not touch the bottom surface of the transmitter during use.

The bottom surface of the transmitter may be hot during and after use for a while, resulting in a burn injury.

Also, do not place it on an object sensitive to heat. Doing so may cause deformation or discoloration.

CAUTION:

Do not block the vent hole of this product.

Do not push the product into a narrow and poorly ventilated space.

Doing so may cause heat to accumulate inside, resulting in a fire or malfunction.

Do not place a heavy item on the product.

Doing so may cause a fire or malfunction.

Do not place the product at a high-temperature location, humid or dusty location, or location subject to oil smoke or steam (such as a cooking table and humidifier).

Doing so may cause a fire or electric shock.

When removing the connection cables, be sure to hold the connector and pull it.

Pulling the cord may damage the cord, resulting in a fire due to an electric shock or short circuit.

When transferring the product, remove the connection cables of equipment beforehand.

Failure to do so may damage the cord or product, resulting in a fire or electric shock.

When not using the product for a prolonged period, remove the power plug from the outlet.

Dust may accumulate in the power plug, resulting in a fire or electric shock.

Do not pull or hang the connection cables.

Doing so may cause the product to fall over or drop, resulting in an injury.

- Keep an eye on children in particular.

Do not put things magnetically affected close to the transmitter, such as a magnetic card and magnetic disk.

■ Maintenance

For maintenance, remove the power plug from the outlet for safety.

Failure to do so may cause an electric shock.

Before Using

Features of the system

The wireless presentation system allows screens displayed on an image output device to be projected (mirroring) on a display or projector installed at a remote location.

Since small screens of a smartphone, notebook computer, etc. can be displayed on a large screen, this system is convenient to show presentation materials on a large display in a meeting, enjoy images on a large display, show images with a display installed at a location where wiring cables is difficult or other cases.

This system is composed of a transmitter and a receiver, and sends images on an image output device to the receiver via wireless LAN using the transmitter.

Also, images can be sent to the receiver from a mobile device (Android device) without using the transmitter.

Using the following methods allows images on an image output device to be displayed on a display or projector.

- ① Send images on an image output device to the receiver using the transmitter to display the images on a display or projector.
- ② Send images on a mobile device (Android device) directly to the receiver using a dedicated application to display the images on a display or projector.
- ③ Send images on a mobile device (Android device) to the receiver using a dedicated application via external wireless LAN to display the images on a display or projector.

Note

- Depending on the usage environment, some of the displayed contents on the application screen or Web setting screen may differ.

Precautions for use

■ When transporting this product

Do not apply excessive vibrations or impacts during transport.

Doing so may damage the internal parts, resulting in a malfunction.

■ When installing this product

Do not install the product outdoors.

This product is intended for exclusive use indoors. Using it outdoors is prohibited by radio wave-related laws.

Do not install the product in the following locations.

- Locations subject to vibrations or impacts such as vehicles and vessels: The internal parts may be damaged, resulting in a malfunction.
- Near the sea or locations where corrosive gases are generated: The life-span of parts may be affected or a malfunction may occur.
- Near high-voltage wires or power sources: The operation of the product may be disturbed.

Do not install the product at a location of 2 700 m (8 853 ft) or higher above sea level.

Doing so may affect the life-span of parts or cause a malfunction.

The operating temperatures for this product are 0 °C to 35 °C (32 °F to 95 °F) at a location of less than 1 400 m (4 593 ft) above sea level, and 0 °C to 30 °C (32 °F to 86 °F) at a location of 1 400 m (4 593 ft) or higher and less than 2 700 m (8 853 ft) above sea level.

Do not block the air inlet and air outlet of the product. Do not use the product in a manner that disturbs inlet and outlet of air.

Doing so may damage the internal parts, resulting in a malfunction.

We are not responsible for any product damage, etc. caused by failures in the installation environment even during the warranty period.

Do not allow both the transmitter and receiver to remain always on.

Keeping them always on may degrade the performance.

The following operations are recommended to maintain the performance.

- Turn off the receiver and transmitter every 24 hours, and then turn them on again.
- Use the [Timed Restart] function (see page 33).

■ About wired LAN

Take sufficient shielding measures at a location where static electricity tends to be generated before using the product.

When using the product at locations where lots of static electricity is generated such as carpet, wired LAN communication tends to be disconnected. In this case, use an antistatic mat, etc. to eliminate the problematic static electricity and noise source from the area surrounding this product and cables.

On rare occasions, LAN connection may not be established due to static electricity or noises. In this case, turn off the power of the product and devices connected to this product once, and then turn on the power of them again.

When there is equipment that generates strong radio waves in the vicinity, install the product sufficiently away from such equipment.

■ Cleaning and maintenance

First, remove the mains plug from the mains socket.

Gently wipe the surface of the case by using a soft cloth to remove dirt.

- To remove stubborn dirt or fingerprints, dampen a cloth with diluted neutral detergent (1 part detergent to 100 parts water), wring out the cloth firmly, and then wipe away the dirt. Finally, wipe away all the moisture with a dry cloth.
- If water droplets get inside the unit, operating problems may result.

Usage of a chemical cloth

- Follow the instructions for the chemical cloth.

Avoid contact with volatile substances such as insect sprays, solvents and thinner.

- This may cause damage to the case or cause peeling of the paint. Furthermore, do not leave it in contact with a rubber or PVC substance for a long time.

Note when using alcohol

- Soak a small amount of alcohol at a concentration of 60 % or less in a soft cloth and wipe the housing. Then be sure to use a dry cloth to wipe it.

Note that wiping the housing with a hard cloth or rubbing it strongly may cause damage. Also, do not allow water droplets to enter the inside to prevent malfunction. Do not directly spray alcohol.

- Do not use antiseptic solutions other than alcohol.

■ Disposal

When disposing the product, ask your local authority or dealer about the correct methods of disposal.

Notes on Using Wireless LAN

Wireless LAN uses radio waves in the 5 GHz bands.

Be sure to read and fully understand the following items before use.

Use this product indoors.

- Using the 5 GHz-band wireless device outdoors is prohibited by the Radio Act.

If at all possible, avoid the use of cellular phones, TV sets or radios near the product.

- Cellular phones, TV sets, radios and similar devices use different radio bands from the product, so there is no effect on wireless communication or the transmission and reception of these devices. However, radio waves from the product may produce audio or video noise.

Wireless communication radio waves cannot penetrate steel reinforcements, metal, concrete, etc.

- Communication is possible through walls and floors made from materials such as wood and glass (except glass containing wire mesh), but not through walls and floors made from steel reinforcements, metal, concrete, etc.

The product may not work properly due to strong radio wave from the broadcast station or the radio.

- If there is any facility or equipment, which outputs strong radio wave, near the installation location, set up the product at a location sufficiently far from the source of the radio wave.

Using the product outside the country

- It is forbidden to take the product outside the country or region where you purchased it, so use it only in the said country or region. Also, note that depending on countries or regions there are restrictions on the channels and frequencies at which you can use the wireless LAN.

Using receivers

- Up to 4 receivers can be installed for this product in the same room. To ensure operations, configure the settings in such a way that radio frequencies output from each receiver do not duplicate with each other.
- Receivers installed in more than one rooms can be used by configuring the settings in the same way as above to avoid duplication of radio frequencies, depending on the state of radio waves leaked from receivers installed in other rooms. However, if the receivers do not operate normally due to interference etc., take necessary measures such as extending the straight-line distance between receivers in each room.

Declaration of Conformity (DoC)

"Hereby, Panasonic Connect Co., Ltd. declares that this product is in compliance with the essential requirements and other relevant provisions of the Directive 2014/53/EU."

If you want to get a copy of the original DoC of this product, please visit the following website:

<http://www.ptc.panasonic.de>

Authorized Representative: Panasonic Testing Centre

Panasonic Service Europe, a division of Panasonic Connect Europe GmbH

Winsbergring 15, 22525 Hamburg, Germany

Indoor use restrictions are to be followed for the following countries if using 5 GHz frequency band.

Austria, Belgium, Bulgaria, Croatia, Cyprus, Czech Republic, Denmark, Estonia, Finland, France, Germany, Greece, Hungary, Iceland, Ireland, Italy, Latvia, Liechtenstein, Lithuania, Luxembourg, Malta, Netherlands, Norway, Poland, Portugal, Romania, Slovakia, Slovenia, Spain, Sweden, Switzerland, Turkey, United Kingdom

WLAN: Maximum Power

23 dBm (5.150 GHz - 5.250 GHz)

Directive: 2014/53/EU

Request Regarding Security

When using this product, take safety measures against the following incidents.

- Personal information being leaked via this product
- Unauthorized operation of this product by a malicious third party
- Interfering or stopping of this product by a malicious third party
- Set a password restrict the users who can log in.
- Make your password difficult to guess as much as possible.
- It is recommended to use a password different from passwords of PC and other devices.
- Change your password periodically.
- Panasonic Connect Co., Ltd. or its affiliate companies will never ask for your password directly. Do not divulge your password in case you receive such inquiries.
- The connecting network must be secured by a firewall, etc.
- When disposing the product, initialize the data before disposing. ([Reset to Factory Default] (see page 42))

Take sufficient security measures.

Precautions on security when using wireless LAN products

- The advantage of a wireless LAN is that information can be exchanged between a PC or other such equipment and an access point using radio waves as long as you are within range for radio transmissions. On the other hand, because the radio waves can travel through obstacles (such as walls) and are available everywhere within a given range, problems of the type listed below may occur if security-related settings are not made.
 - A malicious third-party may intentionally intercept and monitor transmitted data including the content of e-mail and personal information such as your ID, password, and/or credit card numbers.
 - A malicious third-party may access your personal or corporate network without authorization and engage in the following types of behaviour.
 - Retrieve personal and/or secret information (information leak)
 - Spread false information by impersonating a particular person (spoofing)
 - Overwrite intercepted communications and issue false data (tampering)
 - Spread harmful software such as a computer virus and crash your data and/or system (system crash)
- Since most wireless LAN adaptors or access points are equipped with security features to take care of these problems, you can reduce the possibility of these problems occurring when using this product by making the appropriate security settings for the wireless LAN device.
- Some wireless LAN devices may not be set for security immediately after purchase. To decrease the possibility of occurrence of security problems, before using any wireless LAN devices, be absolutely sure to make all security-related settings according to the instructions given in the operation manuals supplied with them. Depending on the specifications of the wireless LAN, a malicious third-party may be able to break security settings by special means. If you cannot perform security settings for your wireless LAN by yourself, please contact the Panasonic dealer.
- Panasonic Connect Co., Ltd. asks customers to thoroughly understand the risk of using this product without making security settings, and recommends that the customer make security settings at their own discretion and responsibility.

Accessories

Check that you have the accessories and items shown.

WPS Basic Set TY-WPS1 / TY-WPS1W		
WPS Receiver (TY-WPR1 / TY-WPR1W).....	WPS Transmitter (TY-WPB1 / TY-WPB1W)	Transmitter case (TY-WPC1)
AC adaptor (DPVF3699ZA/X1)..... (including 4 conversion plugs)	AC adaptor cable (DPVF3515ZA/X1).....	HDMI cable (DPVF3512ZA/X1).....
USB extension cable (DPVF3513ZA/X1).....	Receiver mounting bracket (see page 52)	

WPS USB-C Basic Set TY-WPSC1 / TY-WPSC1W		
WPS Receiver (TY-WPR1 / TY-WPR1W).....	WPS USB-C Transmitter (TY-WPBC1 / TY-WPBC1W)	Transmitter case (TY-WPC1)
AC adaptor (DPVF3699ZA/X1)..... (including 4 conversion plugs)	AC adaptor cable (DPVF3515ZA/X1).....	HDMI cable (DPVF3512ZA/X1).....
Conversion adaptor for pairing (DPVF3516ZA/X1).....	Receiver mounting bracket (see page 52)	

WPS Transmitter Set TY-WP2B1 / TY-WP2B1W		
WPS Transmitter (TY-WPB1 / TY-WPB1W)	Transmitter case (TY-WPC1)	USB extension cable (DPVF3513ZA/X1).....

WPS Transmitter TY-WPB1 / TY-WPB1W	
WPS Transmitter (TY-WPB1 / TY-WPB1W)	USB extension cable (DPVF3513ZA/X1).....

WPS USB-C Transmitter Set TY-WP2BC1 / TY-WP2BC1W		
WPS USB-C Transmitter (TY-WPBC1 / TY-WPBC1W)	Transmitter case (TY-WPC1)	Conversion adaptor for pairing (DPVF3516ZA/X1).....

WPS USB-C Transmitter TY-WPBC1 / TY-WPBC1W	
WPS USB-C Transmitter (TY-WPBC1 / TY-WPBC1W)	Conversion adaptor for pairing (DPVF3516ZA/X1).....

Wireless Presentation System Receiver Board TY-SB01WP	
Receiver Board (TY-SB01WP)	

WPS Receiver TY-WPR1		
WPS Receiver (TY-WPR1)	AC adaptor (DPVF3699ZA/X1)..... (including 4 conversion plugs)	AC adaptor cable (DPVF3515ZA/X1).....
HDMI cable (DPVF3512ZA/X1).....	Receiver mounting bracket (see page 52)	

Attention

- Store small parts in an appropriate manner, and keep them away from young children.
- The part numbers of accessories are subject to change without notice.
(The actual part number may differ from the ones shown above.)
- In case you lost accessories, please purchase them from your dealer. (Available from the customer service)
- Dispose the packaging materials appropriately after taking out the items.

Part Names

Receiver (TY-WPR1 / TY-WPR1W)

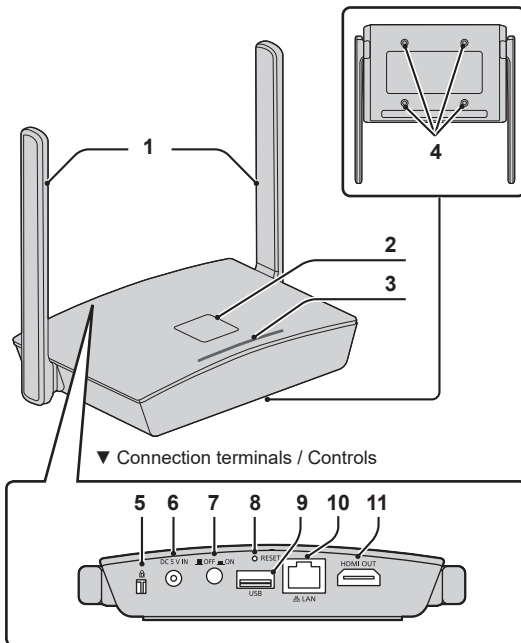

- 1 Antenna**
 - 2 FUNCTION button / LED**
Used to save a pairing file to the USB memory.
 - 3 Indicator**
Displays the power supply status, and connection statuses of LAN and USB.
 - 4 Screw holes for mounting bracket (page 52)**
Used to attach the receiver to the mounting bracket.
-
- ▼ Connection terminals / Controls
- 5 Security Slot**
This security slot is compatible with a Noble Wedge slot.
 - 6 Power input terminal**
 - 7 Power button**
Turns ON/OFF the power of the receiver.
 - 8 Reset button**
Restores the product to the factory default state.
This is the same operation as that when [Reset RX] is selected for [Reset to Factory Default]. (page 42)
Reset operation starts when the reset button is pressed for 5 seconds or more while the power is being supplied. Initialization will be complete in approx. 1 minute.
 - 9 USB terminal (Type-A)**
Connects the transmitter or USB memory when pairing devices.
Use this by connecting an HID device.
 - 10 LAN terminal (RJ45)**
Connects to the network to change the settings of the product.
 - 11 HDMI output terminal**
Connects an imaging device equipped with HDMI input.

* HID device

A compatible mouse and a touch module built into the display operate. For information of operable touch modules, see the Panasonic information site. When using the BQ1 touch panel to operate an externally connected device (PC), change the settings of the BQ1 unit. (page 51)

These can be used only with one screen display. After the USB cable of the HID device is connected, "Hid Driver loading..." appears. When this message disappears, the device can be used.

■ Receiver board (TY-SB01WP)

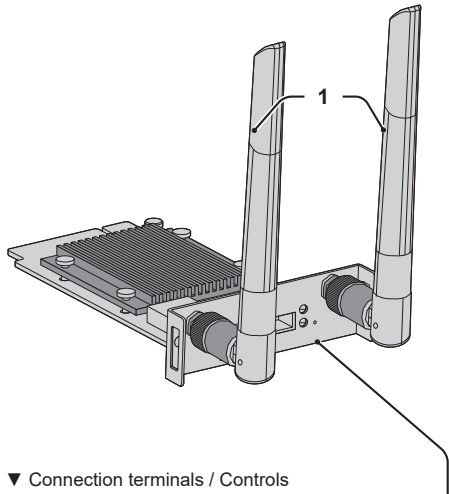

▼ Connection terminals / Controls

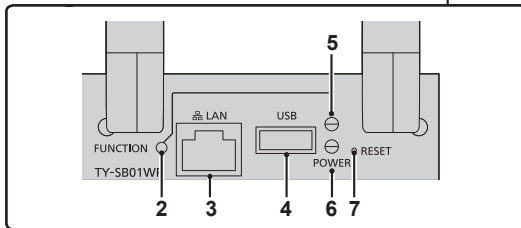

1 Antenna

▼ Connection terminals / Controls

2 FUNCTION button

Used to save a pairing file to the USB memory.

3 LAN terminal (RJ45)

Connects to the network to change the settings of the product.

4 USB terminal (Type-A)

Connects the transmitter or USB memory when pairing devices. Use this by connecting an HID device (mouse, touch module). (page 9)

5 FUNCTION LED

Displays the pairing status.

6 Power Indicator

Displays the power supply status, and connection statuses of LAN and USB.

7 Reset button

Restores the product to the factory default state. Reset operation starts when the reset button is pressed for 5 seconds or more.

■ Transmitter (TY-WPB1 / TY-WPB1W)

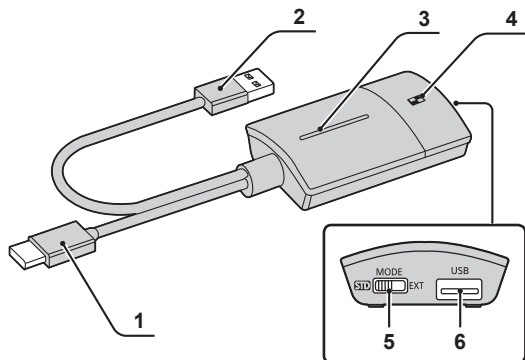

- 1 HDMI input terminal**
Connect to an imaging device equipped with HDMI output.
- 2 USB terminal (Type-A)**
Connect to a USB power supply device.
- 3 Main button / LED**
Switches between on and off of image display.
- 4 Sub button / LED**
Switches to the multi-screen mode.
- 5 Mode switch**
It is used when pairing. (see page 20)
Set the switch to the STD side when receiving information from an HID device.
- 6 USB terminal (Type-A)**
Connects a USB memory when pairing with the receiver.
- 7 USB terminal (Type-C)**
Connect to an imaging device with a USB Type-C terminal that supports DisplayPort Alt Mode output.

■ USB-C transmitter (TY-WPBC1 / TY-WPBC1W)

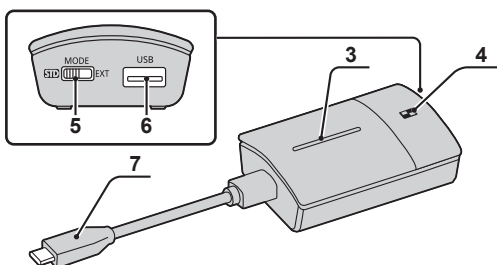

■ Transmitter case

2 transmitters and the USB extension cable (supplied with the TY-WPS1 / TY-WPS1W / TY-WP2B1 / TY-WP2B1W / TY-WPB1 / TY-WPB1W) can be stored.

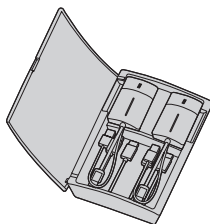

Connection

Before connection, carefully read the operation manual of the device to be connected to this system. Turn off the power of each device before connecting cables.

Connecting the receiver

1 Connect the AC adaptor and AC adaptor cable to the receiver for power supply.

▶ Use an AC adaptor conversion plug that fits the shape of outlet.

<How to remove>

- 1 Press the button
- 2 Remove the plug

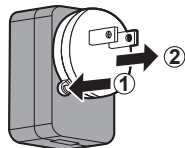

Note

- Do not remove the AC adaptor conversion plug while it is connected to the outlet.

2 Connect a display device such as a display and projector to the receiver with HDMI cable.

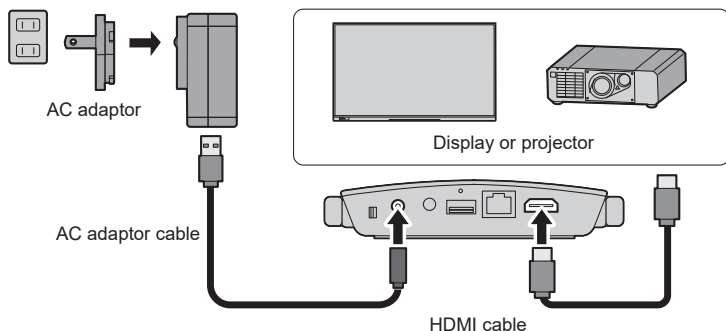

Note

- For power supply to the receiver, use the supplied AC adaptor or a USB power supply device with 5 V/2 A.

3 Press the power button of the receiver. When a standby screen is displayed on the display device, the receiver has completed preparation.

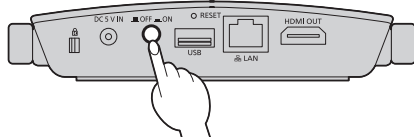

Standby screen

Connecting the transmitter

1 Connect the USB terminal and HDMI input terminal of the transmitter to the image output device.

- For power supply to the transmitter, 5 V/0.9 A power supply is necessary.

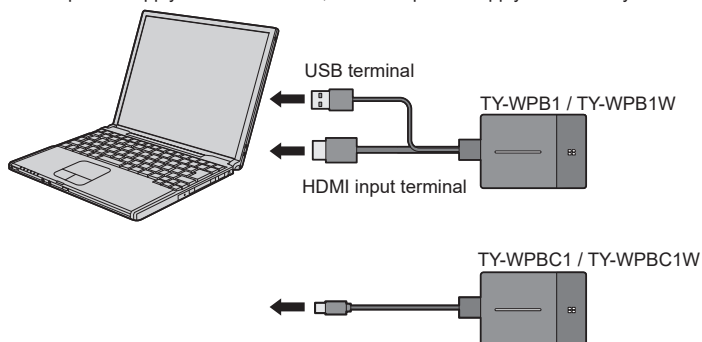

For the USB-C transmitter, connect the USB terminal (Type-C) to the image output device.

Note

- The USB Type-C terminal of an image output device requires the following functions. Confirm the specifications of the device before using.
 - DisplayPort Alt Mode (image output function)
 - Function to supply power to the connected device (5 V/0.9 A)

2 Main LED changes from red blinking (connecting) to white illumination (standby).

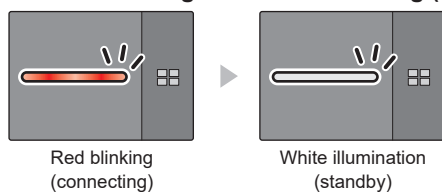

Installation of the receiver board

The installation instruction below is based on the flat panel display SQ1 series as an example.

For attaching or removing this product to or from the flat panel display unit, it is recommended to ask a qualified technician or sales dealer. A malfunction may occur due to static electricity, etc. Consult the sales dealer.

Follow the steps below.

Note

- Be sure to turn off the display unit and connected devices, remove the power plug from the socket, and disconnect the cables from the display.
- When attaching/removing the receiver board, do not allow the metal to damage the back cover or display label.

1 Remove one screw from the side with the guide on the SLOT adaptor.

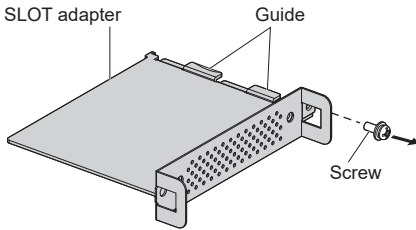

2 Fit the circuit board of the receiver board in the guides of the SLOT adaptor, and bring the circuit board into contact with the hook (one location) and the end faces (two locations) securely.

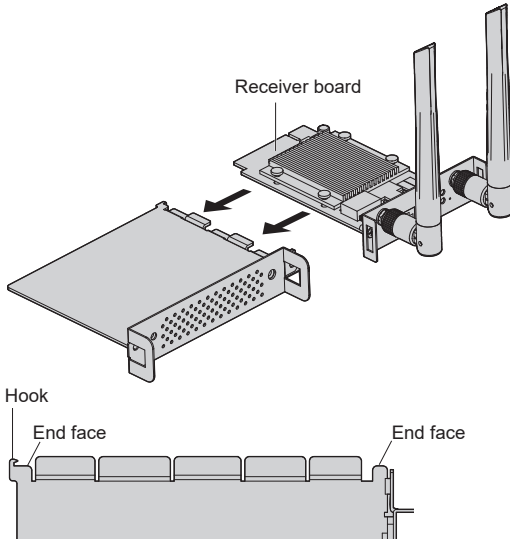

3 Using the screw removed in step 1, fix the receiver board to the SLOT adaptor.

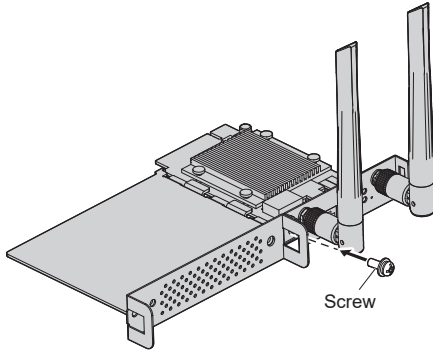

- Tightening torque guideline: 0.5 N·m or less

Note

- Firmly tighten the screw, and check that the hook of the SLOT adaptor fixes the circuit board.
- Check that the surface of the SLOT adaptor and the surface of the circuit board match with each other when the receiver board with the SLOT adaptor attached is viewed from the opposite side of the cover.

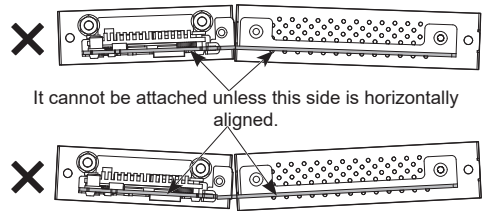
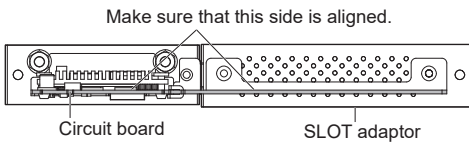

- If there is a lead wire within approx. 3 mm from the end face of the circuit board, the receiver board cannot be attached due to interference with the guide rail. Ensure that there is no lead wire in this range.

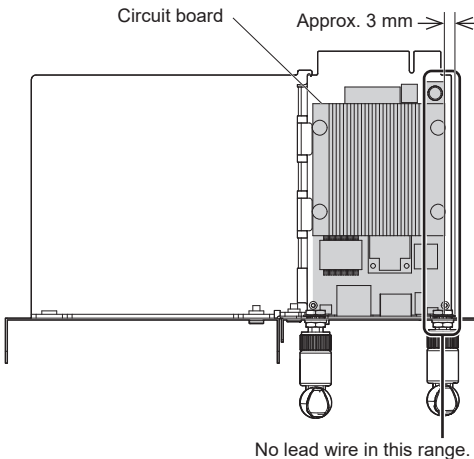

4 Remove the 2 screws, and then remove the slot cover or receiver board from the display unit.

To remove the receiver board, hold the handle of the receiver board and pull it out slowly in the arrow direction.

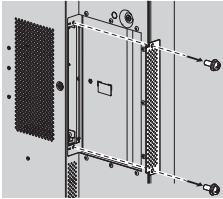

5 Insert the receiver board to the main unit slot, and tighten the 2 screws.

Fix the receiver board with the 2 screws removed in step 4.

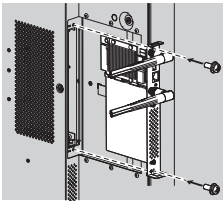

● Tightening torque guideline: 0.5 N·m or less

Note

- When replacing another receiver board with this product, the customer shall keep the replaced receiver board for future repair or servicing.

6 Turn on the display.

7 Switch the input of the display to [SLOT].

8 Pair the receiver board and the transmitter.

(when connecting for the first time, see page 20)

9 When the standby screen appears on the display, preparation of the receiver board is complete.



Standby screen

Basic Use

Single connection

This section describes how to display an image using one transmitter.

1 Press the main button of the transmitter while the standby screen is displayed.

The image is displayed.



Standby screen

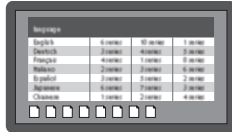

Full screen display

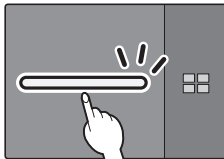

White illumination
(standby)

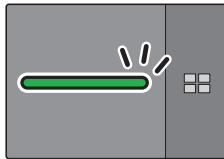

Green illumination
(display)

▶ Pressing the main button again changes the main LED to white and returns to standby state. (The screen returns to the standby screen as well.)

- When using multiple transmitters, the image is switched to the image of the transmitter of which the main button is pressed.

Multi connection

This section describes how to display images simultaneously using multiple transmitters. Images of up to 4 transmitters can be displayed simultaneously.

1 Press and hold the sub button of the transmitter for 1 second or more during full screen display.

The sub LED changes to green illumination, and the multi-screen mode is enabled.

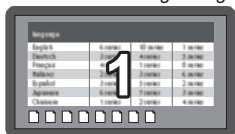

Full screen display

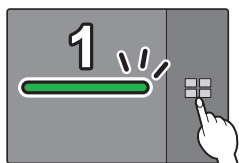

Sub LED
OFF

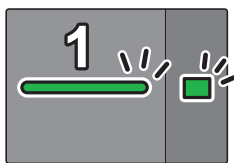

Sub LED
Green illumination
(Multi-screen mode)

2 Press the main button of the transmitter of which the image is to be added.

The image is added.

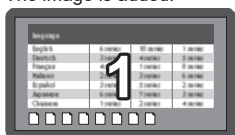

Full screen display

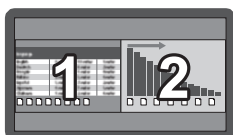

Multi-screen display

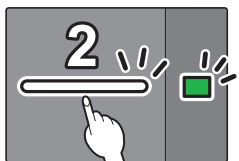

White illumination (standby)
Sub LED Green illumination

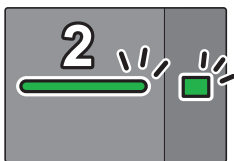

Green illumination
Sub LED Green illumination

Note

- Audio is not output during multi-screen display.

▶ Multi-screen mode cancellation

Press and hold the sub button of the transmitter for 1 second or more.

- The sub LED changes from green illumination to OFF state, and the multi-screen mode is canceled.
- The multi-screen mode can be canceled only when the main LED is lighting green.

Fixing image switching (fixed mode)

When images of 1 transmitter are displayed with multiple transmitters paired and used, you can make a setting that prohibits switching to images of another transmitter.

This setting prevents accidental image-switching operation.

Setting the fixed mode

Press and hold the main button of the transmitter for 1 second or more while an image of one transmitter is displayed.

The main LED changes from green illumination to blue illumination, and the fixed mode is enabled.

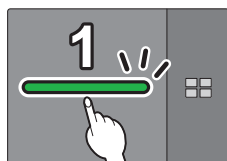
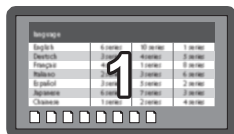
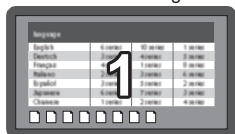

Green illumination

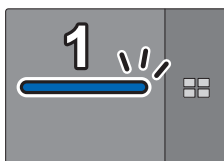

Blue illumination
(fixed mode)

Other transmitters



White illumination
(standby)



Red illumination
(operation disabled)

Canceling the fixed mode

Press and hold the main button of the transmitter for 1 second or more.

The main LED changes from blue illumination to green illumination, and the fixed mode is canceled.

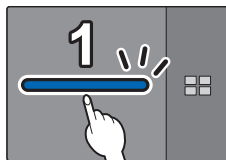

Blue illumination
(fixed mode)

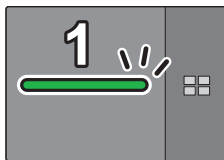

Green illumination
(fixed mode canceled)

Transmitter Extension Method (Pairing)

Pairing settings have been made for transmitter and receiver of TY-WPS1 / TY-WPS1W / TY-WPSC1 / TY-WPSC1W Basic Set.

Pairing by connecting the receiver and transmitter

1 Slide the mode switch to the STD side.

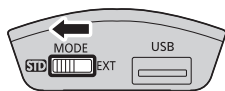

2 Connect the USB terminal of the transmitter to the USB terminal of the receiver / receiver board.

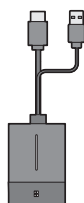
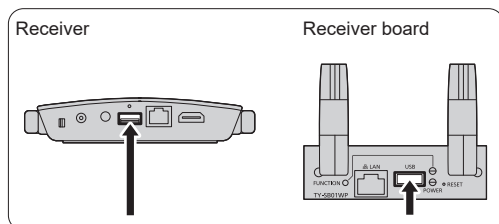

TY-WPB1/
TY-WPB1W



TY-WPBC1/
TY-WPBC1W

To connect the TY-WPBC1/TY-WPBC1W, use the conversion adaptor for pairing supplied with the TY-WPSC1/TY-WPSC1W/TY-WP2BC1/TY-WP2BC1W/TY-WPBC1/TY-WPBC1W.

Wait for a while until the LED of the receiver blinks in white. Then, pairing starts automatically. "Pairing..." (pairing in progress) is displayed on the standby screen.

3 Pairing is complete.

"Pairing OK" is displayed and the LED of the receiver lights up in white.



4 Remove the USB cable of the transmitter from the receiver.

Pairing by saving a file to the USB memory

Supported device

- Commercially available USB memory devices are supported. (Those with security functions are not supported.)
- USB memory devices other than those formatted in FAT16 or FAT32 cannot be used.
- Up to 32 GB of USB memory in size are supported.
- Only single partition configuration is supported.
- Be sure that the USB memory contains no files before using.

1 Connect the USB memory to the USB terminal of the receiver / receiver board.

Receiver

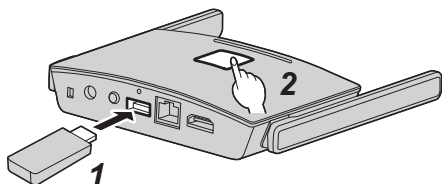

Receiver board

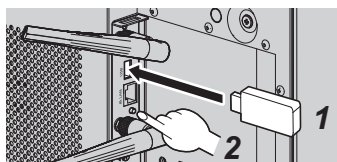

2 Press the FUNCTION button.

The LED lights up in white and the pairing file is saved to the USB memory. Then, "Pairing OK" is displayed on the standby screen.

3 Remove the USB memory.

4 Slide the mode switch to the EXT side.

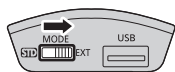

5 Supply power to the transmitter.

TY-WPB1/TY-WPB1W

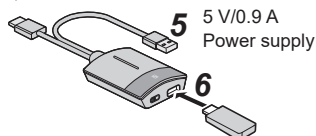

TY-WPBC1/TY-WPBC1W

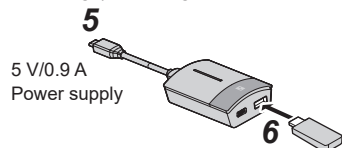

6 Connect the USB memory to the USB terminal of the transmitter.

7 Pairing is complete.

The main LED of the transmitter lights up in white.

8 Remove the USB memory from the transmitter.

About LAN Connection

Since this product is equipped with a network function, connecting the product to a network by wire or wirelessly enables remote control of the product. The Internet needs to be accessible from the connected network in order to update the software of the receiver and transmitter.

■ Wired LAN connection

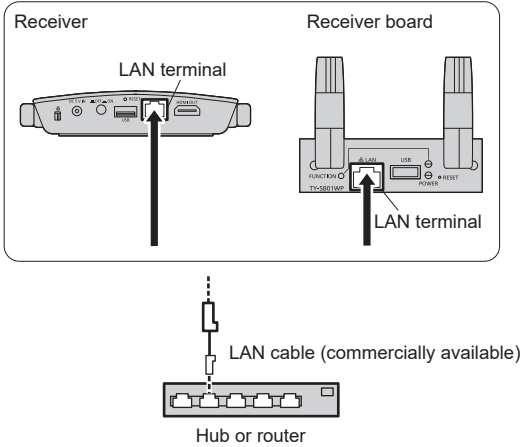

In the initial setup, connecting the LAN terminal of the receiver to the network allows the IP address of the receiver to be automatically assigned by the router using the DHCP function. The assigned IP address is displayed on the standby screen (page 25 ⑦). To manage the receiver (TY-WPR1/TY-WPR1W) / receiver board (TY-SB01WP), use this IP address for connection.

Note

- For LAN cable, use shielded cable, otherwise picture noise may be caused.
- Touching the LAN Terminal with a statically charged hand (body) may cause damage to the device due to its discharge.
Do not touch the LAN Terminal or the metal part of the LAN cable.

■ Wireless LAN connection

Using the wireless function of the receiver (TY-WPR1/TY-WPR1W) / receiver board (TY-SB01WP) enable the product to be connected to an external wireless access point or mobile wireless LAN router (only for 5 GHz wireless LAN), and an external network or the Internet. Make the connection setting in [Network Management] on the Web setting screen. (page 30)

Note

- Connecting to a network and display an image (mirroring) using the wireless LAN connection function of this product increases the possibility of the image to be stuck or noise to be generated. It is recommended that connecting to an external wireless LAN be restricted to the cases such as execution of firmware update.

Using with Android device (Android 5.0 and later versions)

Using the following two methods allows images on an Android device to (Android 5.0 and later versions supported) be projected (mirroring) on a display or projector. Wireless LAN, security measures, etc. can be used according to the usage environment.

- 1 Use an app on the Android device and connect the device to the wireless LAN coming from the receiver.**
- 2 Use an app on the Android device and connect the device to the external wireless LAN.**

1 Use an app on the Android device and connect the device to the wireless LAN coming from the receiver

When mirroring is performed with this method, the Android device cannot be connected to Internet. Use method **2** to perform mirroring with the device connected to Internet.

1 Connect the receiver to the display device with the HDMI cable, and turn on the receiver. (page 12)

The standby screen appears. "About the standby screen" (page 25)

2 Install the dedicated app [PressIT] on the Android device from the Google Play Store.

You can also scan the QR code below to install the app.



The app can also be installed from the Web setting screen. (page 30)

3 Connect the Android device to the wireless LAN coming from the receiver.

SSID and a password necessary for wireless LAN connection are displayed on the lower left of the standby screen. Turn on the wireless LAN function of the Android device and select SSID displayed on the standby screen.

* For the Android device setting method, see the user's manual of your device.

4 Start up the [PressIT] app.

An image with the same design as that of the transmitter is displayed on the Android device. Tap the main button of the transmitter on the screen. (The Android OS may provide a notification. Operate the device according to the notification.)

5 Mirroring starts.

2 Use an app on the Android device and connect the device to the external wireless LAN

Note

- Before installing the dedicated app, make sure that the receiver and Android device are connected to the same wireless LAN. (page 28)

1 Connect the receiver to the display device with the HDMI cable, and turn on the receiver. (page 12)

The standby screen appears. "About the standby screen" (page 25)

2 Install the dedicated app [PressIT] on the Android device from the Google Play Store.

You can also scan the QR code below to install the app.



The app can also be installed from the Web setting screen. (page 30)

3 Start up the [PressIT] app.

An image with the same design as that of the transmitter is displayed on the Android device. Tap the main button of the transmitter on the screen to display. (The Android OS may provide a notification. Operate the device according to the notification.)

4 Mirroring starts.

■ About PressIT app

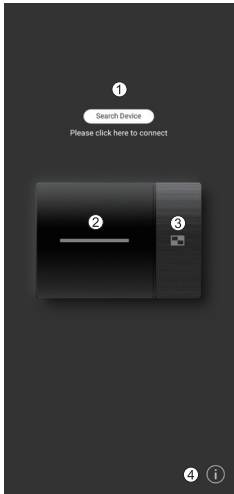

- ① Click [Search Device] to display the list of receivers (SSIDs that have been set) on the connected network. Make connection to the display device.
- ② Performs the same operation as that of the main button of the transmitter.
- ③ Performs the same operation as that of the sub button of the transmitter.
- ④ Displays the Android app information.

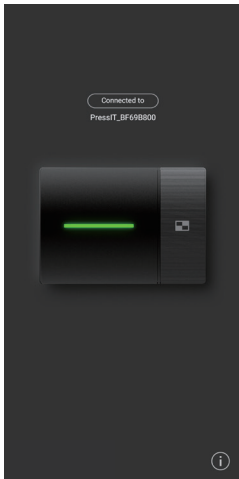

The illustration at left shows the connected state. In this case, images are displayed.

When returning to the home screen or operating another app without exiting the app, those images are projected (mirroring).

Note

- Copyright-protected content cannot be displayed.
- Motion pictures may not be displayed smoothly depending on the processing capability of the Android device or network conditions.
- When making connections on the network to which multiple receivers are connected, there are multiple display devices. Make sure that correct display devices are connected.

Setting

Connect to the Web page of the receiver to configure the settings of this system.

About the standby screen

Turn on the receiver to display the standby screen on the display device.

Note

- For connecting the receiver and display device, see “Connecting the receiver” (page 12).

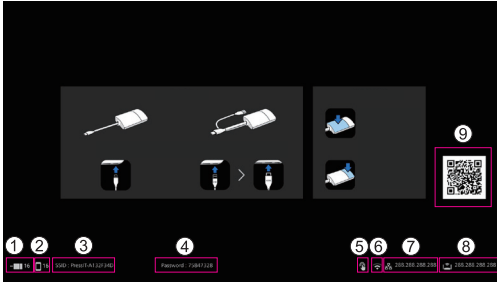

- ① Displays the number of mobile devices connected via wireless LAN of the transmitter or receiver.
- ② Displays the number of mobile devices connected via external wireless LAN.
- ③ Displays SSID. This is used when directly connecting from PC or mobile devices.
- ④ Displays the password. This is used when directly connecting from PC or mobile devices and when connecting to the Web page immediately after purchase or after initialization of data.
- ⑤ Displayed when a mouse or a touch module of the display is connected to the USB terminal of the receiver.
- ⑥ Displayed when connected to a wireless access point or router.
- ⑦ Displayed when connected to an external network (LAN) via a wired LAN or external wireless LAN access point. Use this IP address when connecting from an external network to the receiver.
- ⑧ Receiver's IP address for wireless LAN. Use this IP address for wireless LAN connection.
- ⑨ Displays the QR code linked to the site for downloading the operating instructions.

Note

- Select [Device Management] - [Language] to change the displayed language. (page 31)

■ **When connecting for the first time immediately after purchase**

User ID and password are required when connecting to the Web page of the receiver immediately after purchase or after initialization by pressing the reset button of the receiver. Then, the password needs to be changed.

User ID: PressIT_admin

Password: Enter the password (④) displayed on the standby screen.

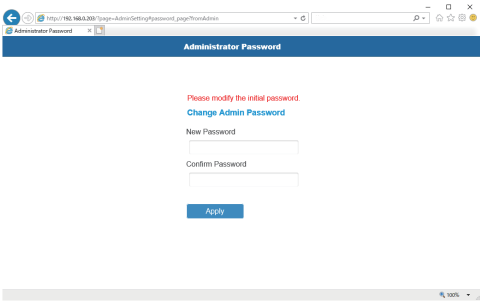
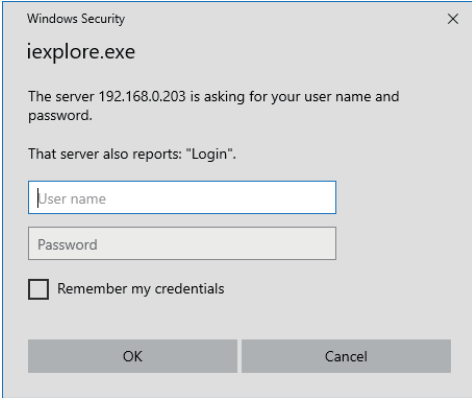

Displaying the Web setting screen

About web browsers

We recommend using the web browsers shown below to operate the Web setting screen.

Chrome	Version 85.0.4183.83 and later versions	Firefox	Version 80.0.1 and later versions
Internet Explorer 11		Safari	Version .13.0.5 and later versions
Edge	Version 84.0.522.52 and later versions		

When configuring the settings in an environment without wireless access point in the surrounding area

Connect to the wireless LAN of the receiver and open the Web setting screen. Note that while operating the web settings using this method, the mobile device cannot be connected to Internet temporarily. SSID and a password necessary for wireless LAN connection are displayed on the lower left of the standby screen.

SSID : PressIT-A132F34D

Password : 75847328

1 Turn on wireless LAN of the PC or mobile device and select SSID displayed on the standby screen.

Above example: PressIT-A132F34D

2 Enter the wireless LAN password.

Above example: 75847328

3 After the connection is complete, enter the IP address displayed on the lower right of the standby screen into the address bar of the web browser, and press Enter.

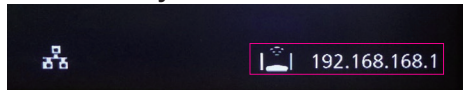

* The IP address on the image is an example and may be different depending on the environment.

When connection is established correctly, the Web setting screen is displayed.

Web setting screen when accessed from PC

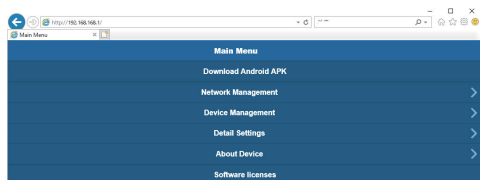

Web setting screen when accessed from smartphone

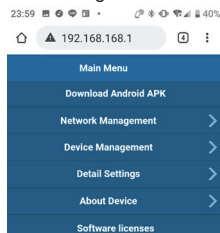

■ **When configuring the settings in an environment where wireless LAN (5 GHz band) access point can be used freely**

Connect the receiver to the external wireless LAN and open the Web setting screen. You can also connect to the external wireless access point different from the wireless access point coming from the receiver to open the Web setting screen. The advantage of this method is that logging in to the Web setting screen is possible with the mobile device connected to the network. However, the password of the external wireless access point must be obtained beforehand.

Obtain the password, etc. from the system administrator managing the local network.

1 After opening the Web setting screen with the procedure in “When configuring the settings in an environment without wireless access point in the surrounding area” (page 27), log in with administrator privileges and select “Network Management”.

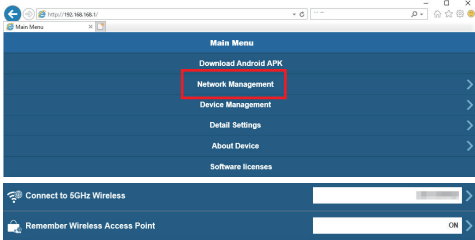

2 Click “Connect to 5GHz Wireless”.



* When a network cable is connected to the receiver, DHCP of the wired LAN is prioritized.

3 Select SSID to connect and enter the password.

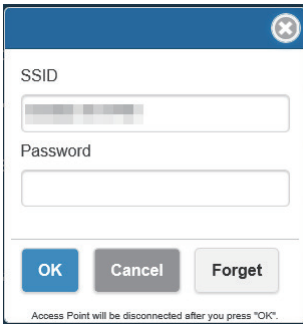

This is a state where connection to Internet is established via external wireless access point.



When the receiver is connected to the external wireless access point, the wireless LAN icon is displayed on the lower right of the standby screen.



To store the external wireless access point in the receiver, set [Remember Wireless Access Point] to [On] and click [OK]. The system restarts.

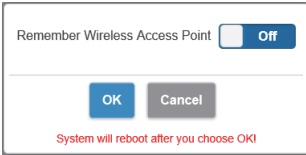

- 4** To open the Web setting screen from the PC or mobile device, confirm that it is connected to the same wireless access point as that of the receiver, enter the IP address displayed on the lower right into the address bar of the web browser, and press Enter.

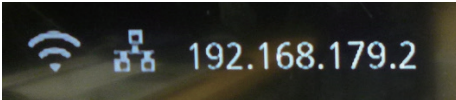

When connection is established correctly, the Web setting screen is displayed.

Web setting screen when accessed from PC

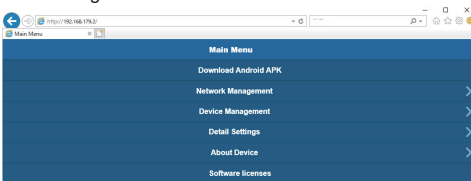

Configuring various settings on the Web setting screen

Settings including [Device Management], [Network Management] and [Detail Settings] can be changed on the Web setting screen.

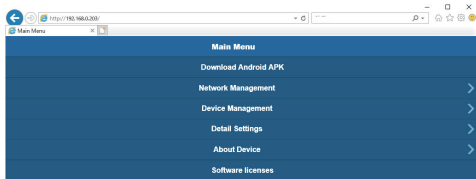

Download Android APK

The Android app (page 23) can be downloaded and installed. Use this app when the device cannot be connected to the Google Play Store. When the app is downloaded from the Web setting screen, confirmation is required to install the app on the Android device since it is not the one downloaded from the Google Play Store. Confirm the version information of the Android device/Android OS.

Network Management

The receiver can be connected to an external wireless LAN via an external wireless access point.

Note

- A wired LAN cannot be used in combination.

Connect to 5GHz Wireless

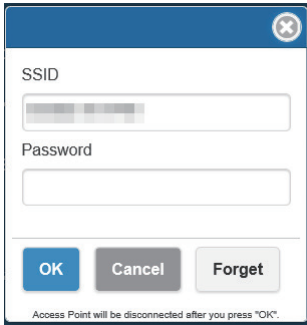

This product supports only the wireless access points using the 5 GHz band.

Enter the SSID and password necessary to connect the mobile device and the receiver to the same wireless access point.

Remember Wireless Access Point



The password connection information of the wireless access point once connected can be stored in the receiver.

- On:** Stores the external wireless access point settings in the receiver.
- Off:** Deletes the external wireless access point settings stored in the receiver.

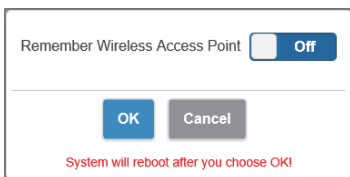

■ Device Management

The Web setting screen has setting options such as Language, Resolution and Max Connection.

● Language

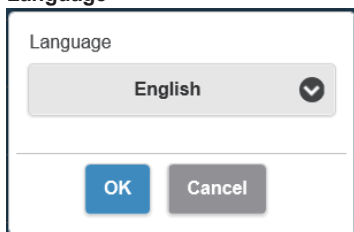

Language

English

OK Cancel

Supports major languages including Japanese, German, French and Chinese. The Web setting screen and standby screen are displayed in the selected language.

● Resolution

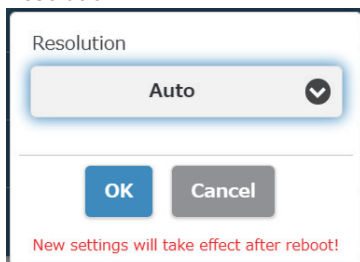

Resolution

Auto

OK Cancel

New settings will take effect after reboot!

This product automatically detects an output resolution suitable for the display. The resolution can be changed manually.

The standard output resolution is 3840 x 2160 (30fps). Up to 3860 x 2160 (30fps) or 4096 x 2160 (24fps) of resolution is supported. 3840 x 2160 (30fps) is generally called 4K.

● Max Connection

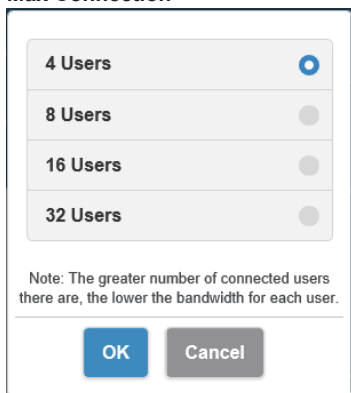

4 Users

8 Users

16 Users

32 Users

Note: The greater number of connected users there are, the lower the bandwidth for each user.

OK Cancel

You can decide the number of the transmitters and mobile devices connected to the receiver. Up to 32 mobile devices can be connected. The initial setting is 4 devices.

Note that the more the connected devices, the less the network band width of each user.

● **Android audio streaming (Firmware version 1.9598.583 and later)**

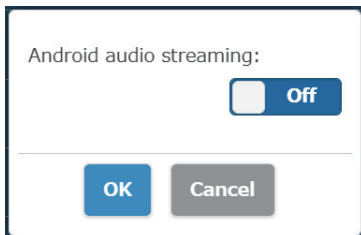

Specifies whether to output the audio of Android from the display device connected to the receiver.

On: Enables the function.

Off: Disables the function.

About [PressIT] app

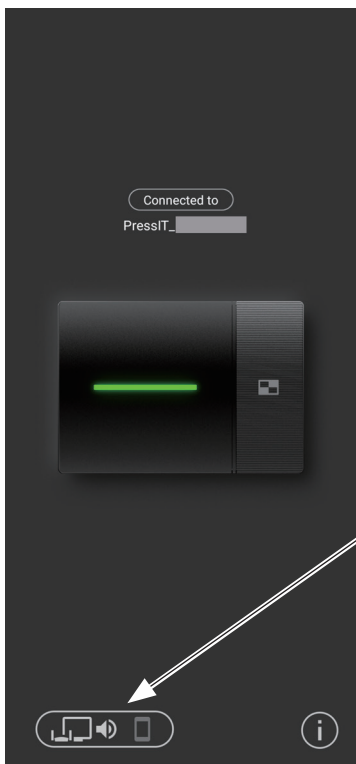

Displays the audio output status using the Android app dedicated to [PressIT]. (App version 0.0.14 and later)

Audio output status display added

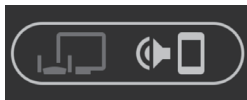

Audio output on the Android device



Audio output on the display/projector

Note

- Since this function uses the Bluetooth function on the Android device, enable Bluetooth on the setting menu.

● Screen mode

Fit to Screen

Stretch to Full Screen

New settings will take effect after reboot!

OK Cancel

Adjusts the size of images.

Fit to Screen: Displays images with the aspect ratio of input signals.

Stretch to Full Screen: Displays images in full screen.

● Timed Restart

Off

8 hours

4 hours

2 hours

New settings will take effect after reboot!

OK Cancel

Restarts after the time selected on the menu has elapsed when no operation is performed.

● HDMI-CEC control

HDMI-CEC control:

Input Change Timing

RX Power on:

TX connected:

OK Cancel

Sets the link function with a display or projector.

Input Change Timing (Firmware version 1.9598.583 and later)

RX Power on

Sets the function to turn the power ON or switch input when the receiver is turned on.

On: Enables the function.

Off: Disables the function.

TX connected

Sets the function to turn the power ON or switch input when the transmitter is turned on.

On: Enables the function.

Off: Disables the function.

Note

- This product does not support VIERA LINK.

● HDCP

HDCP:

New settings will take effect after reboot!

OK Cancel

This switches the HDCP setting On or Off.

When connecting the product to an HDCP-incompatible device, set this to [Off].

Note

- Switching the setting [On]/[Off] restarts the product automatically.

■ **Detail Settings**

This setting function is designed mainly for persons in charge of information system department and network administrators, enabling more detailed setting changes.

● **Wireless Channel**

Sets the Wireless channel. This product provides the following options.

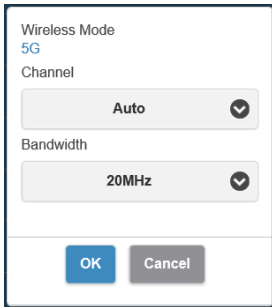

**Channel
Bandwidth**



Can not change channel when connected to an external router.

* Note that when the receiver is connected to an external wireless access point, the Wireless channel cannot be set.

● **Signal Strength (Firmware version 1.12412.676 and later)**

Sets the strength.

Configure this setting to suppress the interference of radio waves generated when multiple transmitters and receivers are installed in proximity.

① **Select [Signal Strength] on the [Detail Settings] screen.**

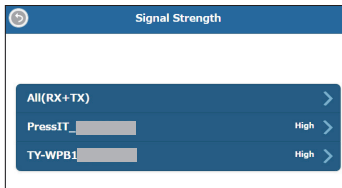

The transmitters connected to the receiver are displayed in the list.

Select a device to be set.

To apply the same setting to the receiver and all transmitters, select [All(RX+TX)].

② **Set the strength.**

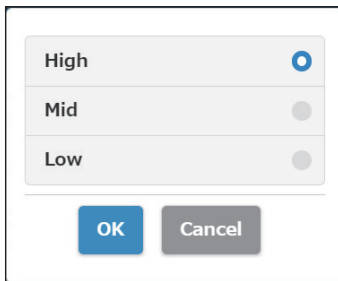

High: Sets the strength of the wireless to the maximum.

Mid: Sets the strength to 70%.

Low: Sets the strength to 40%.

② Set reboot.

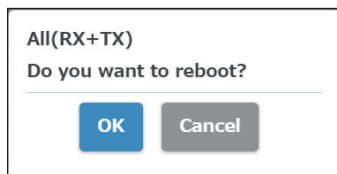

Set whether to reboot the device of which the setting has been changed.

When changing the settings of multiple devices in succession, select [Cancel].

Note

- Reboot is applicable only to the device for which the setting is changed just before the reboot.
- When settings for multiple devices are changed by selecting [Cancel], turn off and on the power manually.

● LAN IP Settings

Network settings can be manually configured including IP address, gateway, netmask and DNS server.

A configuration screen for LAN IP settings. It includes a toggle for "Automatic" (set to "On"), and input fields for "IP Address" (192.168.0.203), "Default Gateway" (192.168.0.1), "Subnet Mask" (255.255.255.0), "DNS1" (192.168.0.1), and "DNS2" (empty). A note at the bottom states "Changes take effect immediately after pressing OK". There are "OK" and "Cancel" buttons at the bottom.

● SSID

Changes the name of SSID, hides SSID and disables SSID.

A configuration screen for SSID settings. It includes a "New SSID" field with the value "PressIT_BF9015D3" and a note "New settings will take effect after reboot!". There are two toggle switches: "Hide SSID" (set to "Off") and "Turn Off SSID" (set to "Off"). There are "OK" and "Cancel" buttons at the bottom.

Hide SSID: Setting this to [On] hides SSID displayed on the standby screen.

* Be sure to take a note before setting.

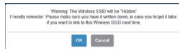

Turn Off SSID: Setting this to [On] disables the SSID function of the receiver. Communication is disabled between transmitter and receiver. Even if pairing is performed, communication is disabled.



● **Password**

Changes the wireless LAN connection password for the receiver. The administrator can hide the wireless LAN password on the standby screen for security enhancement.

Types of characters that can be set: Alphanumeric characters (0 to 9, a to z, A to Z)

Number of characters that can be set: 8 to 15 characters

Note

- Changing password requires pairing again.

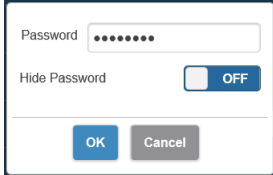

● **My Screen**

Uploading an arbitrary image allows the background of the standby screen to be changed. The image size should be less than 2 MB with 1920 x 1080 in PNG format.

Note

- Note that once the background is changed, the product needs to be initialized to restore the image to the original one. (page 42 "Reset to Factory Default")



● **Wireless Display (Firmware version 1.14366.852 and later)**

Using the Wireless Display function enables screens and audio of a mobile terminal supporting Miracast to be mirrored on the receiver.

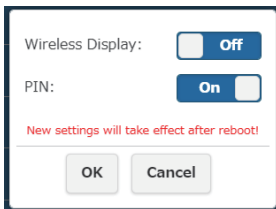

Wireless Display

On: Enables the function.

Off: Disables the function.

When [Wireless Display] is set to [On], "DIRECT-" is appended to the head of SSID.

PIN

On: Enables the function.

Off: Disables the function.

PIN function

When this function is enabled, depending on the mobile terminal to be used, the entry of PIN may be required for connection. If this is the case, enter the 8-digit PIN number displayed at the bottom of the screen.

Standby screen when [Wireless Display] is set to [On]

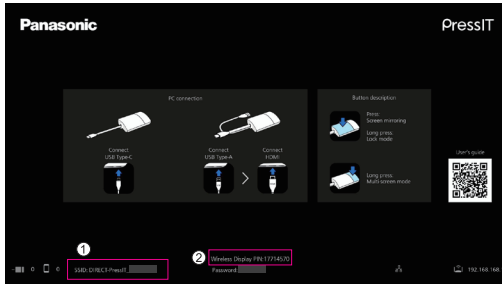

① "DIRECT-" is appended to the head of SSID.

② PIN display

Note

- The Wireless Display function can be used only when the mobile terminal supports Miracast. If connection fails, check if the operating system in use supports Miracast. For operation method for the mobile terminal, refer to the user's manual, etc. of your terminal.
- When [Multicast] is set to [On], the Wireless Display function cannot be used. Accordingly, [Wireless Display] cannot be set to [On].
- Re-pairing is required when the firmware version of the receiver is upgraded from 1.12412.676 or older to 1.14366.852 or later, and [Wireless Display] is set from [Off] to [On] to use the transmitter.
- The Wireless Display function cannot be executed during Lock mode by the transmitter.
- When [Wireless Display] is set to [On], the following menu item is disabled.
 - Max Connection
- When [Wireless Display] is set to [On], the following menu items cannot be changed.
 - Hide SSID / Turn Off SSID
The setting is forcibly set to [Off].
 - Password
- When the firmware version of the receiver is upgraded from 1.12412.676 or older to 1.14366.852 or later, it is necessary to download the module of the Wireless Display function via Internet connection. Starting up the receiver connected to the Internet automatically downloads the modules. After downloading is complete, the Internet connection is not necessary. If the modules have not been downloaded, the following message is displayed for a few seconds at the startup of the receiver.

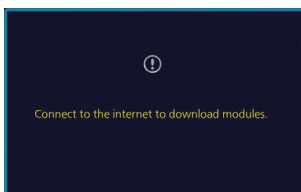

● **Administrator Password**

Changes the administrator password. It is recommended to change the administrator password periodically for security enhancement.

Types of characters that can be set: Alphanumeric characters (0 to 9, a to z, A to Z)

Number of characters that can be set: 6 to 64 characters

[Change Admin Password](#)

New Password

Confirm Password

● **Screen Saver**

Specifies the time until the screensaver is activated.

When the screensaver is activated, the image being projected disappears.

Pressing the main button of the transmitter cancels the screensaver.

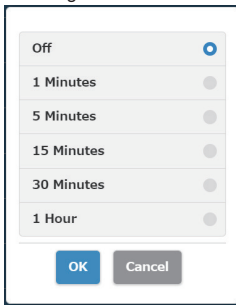

Note

- [1 Minutes] and [5 Minutes] can be selected with firmware versions of 1.9598.583 and later.

● **WPA/WPA2 Enterprise**

Using this function, an electronic certificate key file supporting encryption communication can be uploaded. This function is designed for persons in charge of information system department and network administrators.

[Upload Digital Certificates](#)

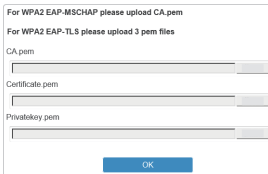

● Upgrade

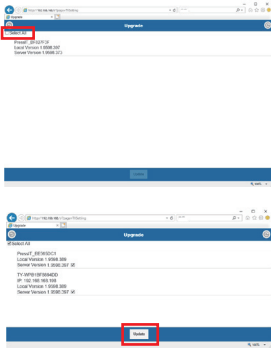

The firmware of the receiver and transmitter can be to the latest versions. This product needs to be stably connected to Internet to upgrade the firmware. It is strongly recommended to use the same firmware version for the receiver and transmitter upgraded of this product.

The firmware can be upgraded with the following method.

- ① Connect the transmitter to an external power source.
- ② Confirm that the receiver is connected to Internet and the receiver and transmitter have been paired.
- ③ Click the [Select All] check box to upgrade all the firmware of the receiver and transmitter collectively.
- ④ Tap the [Update] button to start downloading the latest firmware. This process will finish in a few minutes. Please wait for a while.

Note

- The firmware upgrade information displayed for [Upgrade] on the [Detail Settings] menu shows the confirmation result of the receiver version.
- When the firmware upgrade for the receiver is available, a mark to prompt you to upgrade the firmware is displayed on the receiver at the lower right of the standby screen.

● Multicast (Firmware version 1.14366.852 and later)

Multicast is a function to mirror video and audio from one transmitter to multiple receivers.

To use the Multicast function, a wireless LAN router is required that can be fixed to the W52 channel in 5 GHz band.

Pre-setting 1 (receiver setting)

This setting is required for all receivers that perform Multicast.

1-1 Connect the receiver to the router

On the Web setting menu, set [Remember Wireless Access Point] to [On] in [Network Management], and configure the connection setting with the router in [Connect to 5GHz Wireless].

If the receiver is connected to the router via wired LAN, this setting is not required.

1-2 Multicast menu setting

Select [Multicast] from [Detail Settings] on the Web setting menu.

Multicast

On: Enables the function.

Off: Disables the function.

Cast Group

Set the Cast Group name (within 16 alphanumeric characters).

Multicast is enabled for receivers set in the same Cast Group.

Security

Select the security setting for the router.

Security standards that support the Multicast function are displayed.

Multicast does not support WPA / WPA2-Enterprise.

Device Name

Enter SSID of the router.

Password

Enter the connection password for the router.

Click [OK] to restart the receiver.

Pre-setting 2 (pairing)

Pair the transmitter to be used with one of the receivers for which “Pre-setting 1” has been completed.

Standby screen after the completion of pre-setting

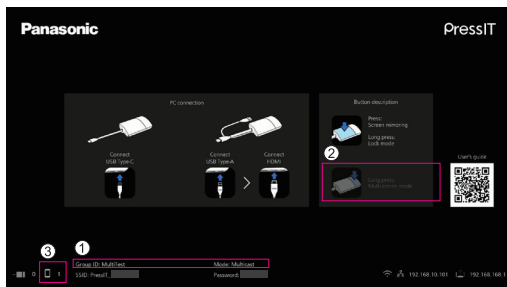

- ① Group ID (Cast Group set as above) and “Mode: Multicast” are displayed at the bottom.
- ② Since the Multi-screen mode is not supported, the operation guide display is changed.
- ③ Since the transmitter during Multicast is connected via external wireless LAN, the number of connections is displayed here.

Note

- When the Multicast setting is changed, pairing of the transmitter is required again.
- Depending on the network connection status, delay or other problems may occur in Multicast video. If the delay concerns you, try wired LAN connection between the receiver and the router.
- When [Wireless Display] is set to [On], the Multicast function cannot be used. Accordingly, [Multicast] cannot be set to [On].
- When [Multicast] is set to [On], the following functions are not supported.
 - Multi-screen mode
 - Operation with HID devices
 - Mirroring from the PressIT application for Android/iOS
 - Downloading of the pairing file
- Please note that when communication between the router and the receiver is unavailable for a certain period of time, [Multicast] is forcibly set to [Off].

When communication between the router and the receiver is unavailable, a message is displayed in the center of the standby screen as shown below.

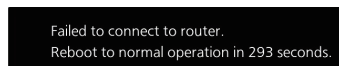

If communication between the router and the receiver cannot be resumed while the message is displayed, [Multicast] is forcibly set to [Off], and the receiver restarts. (When communication can be resumed, the Multicast setting can be maintained.)

● Download Pairing File

Download the pairing file and save it on a USB flash drive.

After downloading is complete, perform step 5 and the subsequent steps in “Pairing by saving a file to the USB memory” (page 21) to copy the pairing file to the transmitter.

The receiver and transmitter of the TY-WPS1/TY-WPS1W basic set are paired at the time of shipment. When the transmitter is initialized or a new transmitter is additionally purchased, pairing with the receiver is required before using.

● Background Color setting

Specifies the background colors for the standby screen and no-signal image.
[Black] or [Blue] can be specified.

Note

- When the [My Screen] is specified, this setting is not reflected.

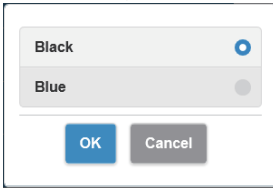

The screenshot shows a dialog box with two radio button options. The top option is 'Black' with a blue dot next to it, indicating it is selected. The bottom option is 'Blue' with a grey dot. Below the options are two buttons: 'OK' in blue and 'Cancel' in grey.

● Date/Time setting

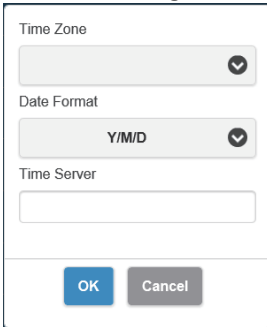

The screenshot shows a settings screen with three sections. The first section is 'Time Zone' with a dropdown menu. The second section is 'Date Format' with a dropdown menu set to 'Y/M/D'. The third section is 'Time Server' with an empty text input field. At the bottom are 'OK' and 'Cancel' buttons.

Specifies the time zone and the display style of date displayed on the standby screen.

Date Format:

Refer to [Date/Time setting] (page 46).

Time Server:

Sets the NTP server.

When the NTP server is not specified, a server registered beforehand is accessed.

Date and time shows the following information.

1. Information obtained from the NTP server via wireless LAN or wired LAN of the receiver (priority)
2. Information from HDMI-CEC of the corresponding display or projector

● Reboot

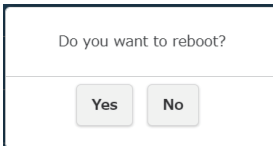

The screenshot shows a confirmation dialog box with the text 'Do you want to reboot?'. Below the text are two buttons: 'Yes' and 'No'.

Restart the product when the firmware is upgraded to the latest version or the receiver does not respond.

Tap [Reboot] and select [Yes].

● Reset to Factory Default

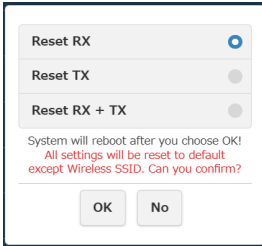

Initializes this product to the default state. Note that the customized language setting, resolution setting, wireless LAN setting, etc. once stored are initialized. (SSID is not initialized.)

When the transmitter is initialized, the paired state between the receiver and transmitter is canceled. Perform pairing according to the procedure in "Transmitter Extension Method (Pairing)" (page 20) after initialization.

Reset RX:

Initializes the receiver only.

Reset TX:

Initializes the transmitter only.

Initialization is applicable to active transmitters that have been paired with a receiver.

Reset RX + TX:

Initializes both the receiver and transmitter.

■ About Device

Displays [SSID], [Firmware Version], [Wireless Channel] and other basic information related to this product. When the transmitter is connected, the basic information of the transmitter is also displayed.

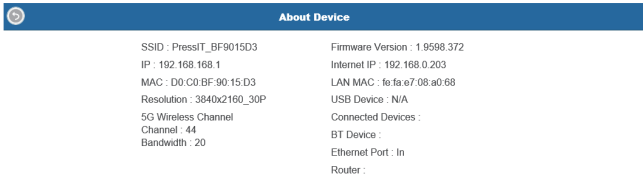

■ Software licenses

Displays the software license description.

[Setup] menu (display setting)

When this product is connected to the compatible display and the [Setup] menu is set, the following functions can be used.

This section explains each setting using the display SQ1 series as an example. For settings on other models, see the Panasonic information site.

■ Signal

Examples of [Signal] submenu screen
When HDMI is selected

Signal	
YUV/RGB-in select	YUV
Cinema reality	Off
Noise reduction	Auto
MPEG noise reduction	Off
Signal range	Full(0-255)
Frame creation	Off
Dynamic backlight control	Off
EDID select	4K/60p/HDR
H-freq.	67.50 kHz
V-freq.	30.00 Hz
Dot clock freq.	297.00 MHz
Signal format	3840x2160/30p
HDCP status	Protected

● [EDID select]

This menu is displayed in HDMI 1 and HDMI 2 inputs. EDID data of each terminal is switched.

[4K/60p/SDR]: Sets EDID compatible with 4K video signals (Max. 4 096 x 2 160 dots, Max. vertical scanning frequency 60 Hz).

This EDID supports SDR (Standard Dynamic Range). HDR (High Dynamic Range) is not supported.

[4K/60p/HDR]: Sets EDID compatible with 4K video signals (Max. 4 096 x 2 160 dots, Max. vertical scanning frequency 60 Hz).

This EDID supports HDR (High Dynamic Range).

[4K/30p]: Sets EDID compatible with 4K video signals (Max. 4 096 x 2 160 dots, Max. vertical scanning frequency 30 Hz).

[2K]: Sets EDID compatible with 2K video signals (Max. 1 920 x 1 200 dots).

Note

- This function is explained using the Panasonic display SQ1 series as an example. Depending on the model, the setting items differ.
- When EDID is set to [4K/60p/SDR] or [4K/60p/HDR], images of 4K/30p are output.
- When the setting is changed, the image disappears for approx. 10 seconds, and then the specified image format is output.
- When [Resolution] on the Web setting screen is set to something other than [Auto], the settings on this menu are not reflected.
- When [Wireless presentation link] is set to [Off], the settings are not reflected until the receiver is restarted after this menu is changed.

● Input signal display (When receiver board input is selected)

Displays the frequencies of the signal currently being input, and the type of signal.

H-freq.	33.72	kHz
V-freq.	60.00	Hz
Dot clock freq.	74.18	MHz
Signal format	1080i/60i	
HDCP status	None	

When receiver board input (SLOT) is selected, the following information is displayed.

- When the image of the transmitter is displayed, the information of image signal input to the transmitter is displayed.
- When the image of the transmitter is not displayed (standby screen is displayed), the information of signal output from the receiver board is displayed.

■ Panasonic display link function

Just connect the receiver to a Panasonic display supporting this product using HDMI cable and turn them on to perform the link operation. (It is necessary to set [Wireless presentation link] to [On].)

Set link function details in the following setting menus.

■ Power on settings

Makes various settings at power-on.

[Power on settings] - submenu screen

Power on settings	
Initial input	◀ Off ▶
Initial startup	Last memory
Initial VOL function	Off
Initial VOL level	0
Power ON screen delay	Off
Information(No activity power off)	Off
Information(Power management)	Off
Information(Display upside-down)	Off
Quick start	Off

● [Quick start]

This function quickly turns the power on at power-on.

[Off]:

Turns the power on in a usual manner at power-on.

[On]:

Quickly turns the power on at power-on.

Note

- When this function is set to [On], power consumption is increased in standby mode.
- When this setting is set to [On], the power indicator in standby mode lights in orange (red/green).
- When supplying power to the receiver from the USB terminal of the display, set this to [On].

■ External device link settings

Sets external device link.

[External device link settings]- submenu screen

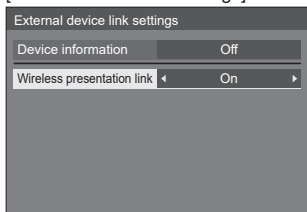

● [Device information]

Sets whether to display or hide the information of the device connected to the HDMI terminal.

[Off]: Connected device information is not displayed.

[On]: Connected device information is displayed as shown below.

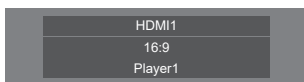

Note

- The obtained information of either signal or HDMI-CEC is displayed.
- Up to the first 16 characters obtained are displayed.

● Wireless presentation link

Sets the link of the Display with this product.

[Off]: Does not link with this product.

[On]: Links with this product.

Note

- When this product is connected to the HDMI terminal, the link function works.
- The following functions are fixed.
 - These settings are held even if this function is switched from [On] to [Off]. The settings can be changed on each setting menu.
 - [Picture mode] is fixed to [Graphic].
 - [HDMI-CEC control] is fixed to [Enable]. [Display → Device] is fixed to [Power off / on]. [Device → Display] is fixed to [Power off / on].
- Even if this function is set to [Off], the HDMI-CEC function works.

■ [Wireless presentation settings]

Note

- Approx. 5 seconds may be required to reflect the menu settings.
[Wireless presentation settings] - sub menu screen

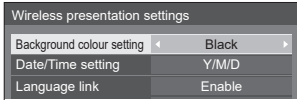

● [Background colour setting]

[Black]: The background color for the standby screen and no-signal image is set to black.

[Blue]: The background color for the standby screen and no-signal image is set to blue.

Note

- When the image is changed with the [My Screen] function on the Web setting screen, this setting is not reflected.

● [Date/Time setting]

Specifies the display style of date on the standby screen.

[Y-M-D]:	e.g. 2021-08-24	[M-D-Y]:	e.g. 08-24-2021
[Y/M/D]:	e.g. 2021/08/24	[M/D/Y]:	e.g. 08/24/2021
[Y.M.D]:	e.g. 2021.08.24	[M.D.Y]:	e.g. 08.24.2021
[D-M-Y]:	e.g. 24-08-2021	[M D,Y]:	e.g. 08 24,2021
[D/M/Y]:	e.g. 24/08/2021	[Off]:	Date is not displayed on the standby screen.
[D.M.Y]:	e.g. 24.08.2021		

Note

- When this is set to [Off], the setting is applied at the next startup of this system.
- There is the same menu on the Web setting screen as this menu item. Since the setting on the display is prioritized, when the system is started next time or the HDMI cable is connected/disconnected, the setting value on the display is reflected.

● [Language link]

[Enable]: Sets the language for the standby screen, no-signal image and Web setting screen to the language set for [OSD language].

[Disable]: Sets the language for the standby screen, no-signal image and Web setting screen to the language set for [Language] on the Web setting screen.

■ HDMI-CEC settings

Set for HDMI-CEC function.

For details of HDMI-CEC function, refer to "Using the HDMI-CEC function". (see page 48)

[HDMI-CEC settings] - submenu screen

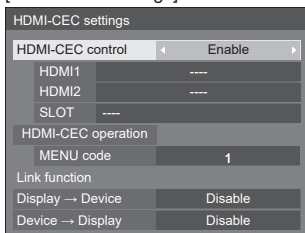

● [HDMI-CEC control]

Enables/Disables the HDMI-CEC function.

[Disable]: Disables HDMI-CEC control.

[Enable]: Enables HDMI-CEC control.

Note

- Setting this item to [Enable] enables the HDMI-CEC function for this product and display.

● [HDMI1] / [HDMI2] / [SLOT]

[PressIT] is displayed for a terminal to which this product is connected.

● [MENU code]

No code is assigned to this system.

● [Display → Device]

Enables/Disables the Display to perform interlocking control of the HDMI-CEC compatible device.

[Disable]: Disables the Display to perform interlocking control of the HDMI-CEC compatible device. Even if the power status of the Display changes, the power status of the device will not be affected.

[Power off]: Turning the Display off (standby) turns off (standby) all the devices connected to the HDMI 1, HDMI 2 or SLOT terminal. The power-on operation is not interlocked.

[Power off / on]: The device turns off/on (standby) in conjunction with the power-off/on (standby) operation of the Display.

● [Device → Display]

Enables/Disables the HDMI-CEC compatible device to perform interlocking control of the Display.

[Disable]: Disables the device to perform interlocking control of the Display. Even if the power status of the device changes, the power status of the Display will not be affected.

[Power on]: Turning on the device turns on the Display, and the input (HDMI1 / HDMI2 / SLOT) is switched to that of the device.

[Power off / on]: The power status of the Display interlocks with the power-off/on operation of the device.

Using the HDMI-CEC function

The HDMI-CEC function allows the display to be turned on/off or the input to be switched by linking the operation of this product.

■ CEC-ON link

The display is turned on (image-receiving state) when it is turned off (standby state). The image of this product is projected by switching to the input to which this product is connected.

ON link is enabled by performing the following 4 operations.

(1) When the receiver is turned on

When the receiver is switched from off to on, the display is turned on and switched to the input to which the receiver is connected.

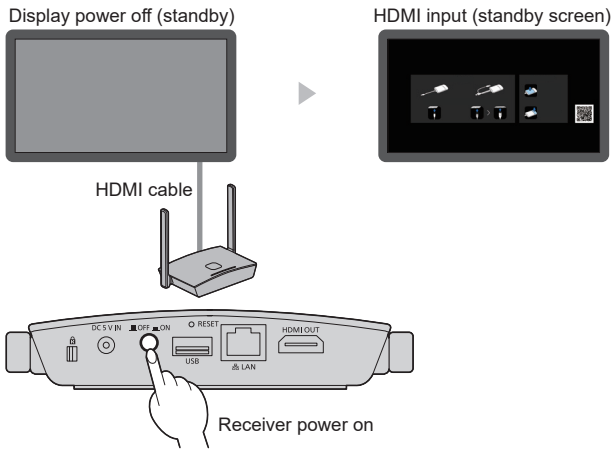

(2) When the transmitter is turned on

When the USB terminal of the transmitter is connected to PC, etc. and the power supply starts, the display is turned on and switched to the input to which the receiver is connected.

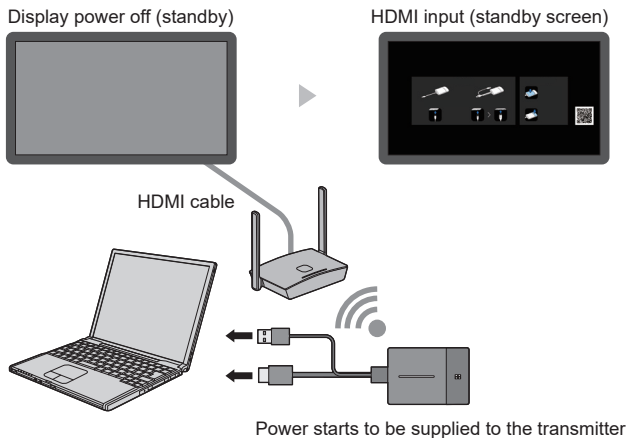

(3) When the image from the transmitter is displayed in standby state

When the transmitter is in standby state, press the main button to send the image to the receiver. Then the display is turned on and the image is displayed.

The input of the display is linked to the operation of the transmitter and switched to the input to which the receiver is connected.

e.g.) PC input for display

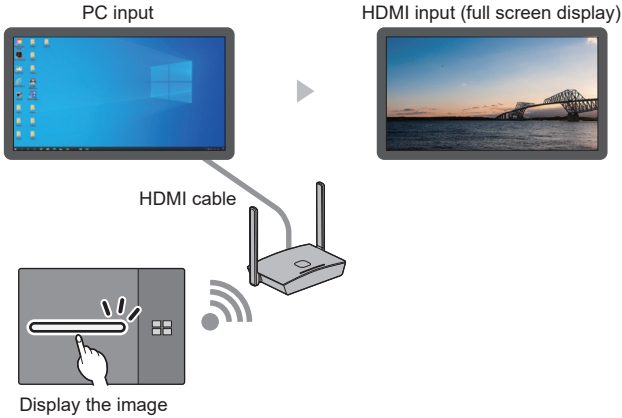

(4) In multi-screen mode

Press the main button in multi-screen mode to add an image. Then the display is turned on and the multi-screen display appears.

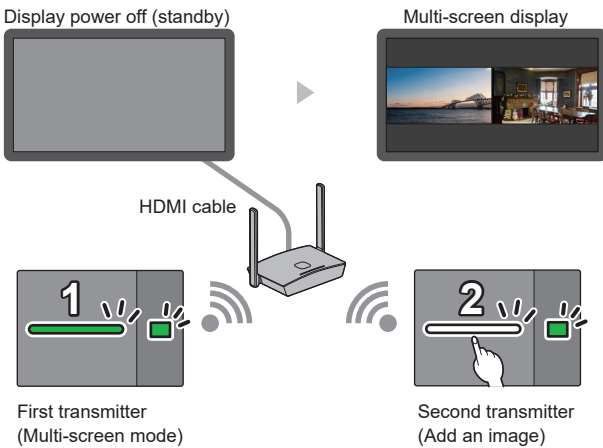

■ **CEC-OFF link**

Performing the following 2 operations allows the display to be turned off (standby state).

(1) When the screensaver is activated

When the screensaver of this product is activated while the transmitter is in standby state, the display is turned off.

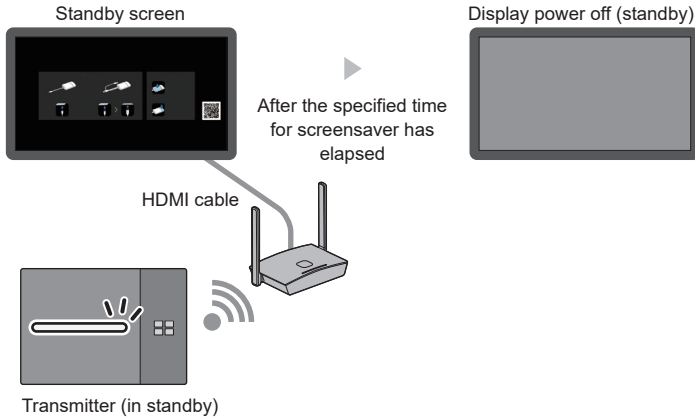

(2) When the transmitter is standby state

Press and hold the main button and the sub button of the transmitter simultaneously while the transmitter connected. Then the display is turned off.

When the transmitter enters the standby state, the main LED blinks in red.

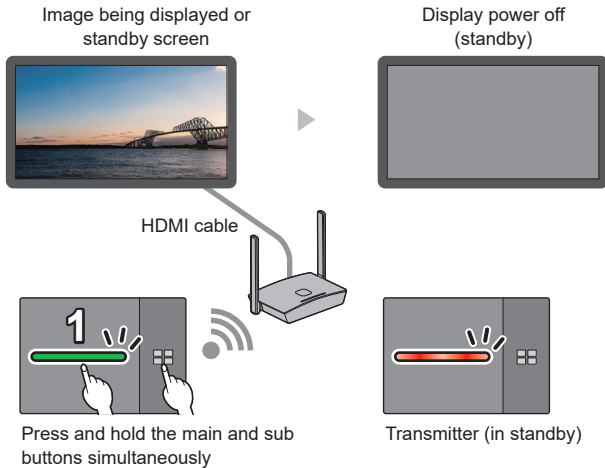

Note

- To restore the transmitter from standby state to the active state, disconnect and connect the USB terminal of the transmitter.

Using “HDVC” on this system

When using an HDCP-incompatible device including the PC sharing function of Panasonic video conference system “HDVC” with this system, perform the operation on the back side.

- 1 Press and hold the FUNCTION button of the receiver for 10 seconds or more.**
- 2 When the LED lights in red, release your finger.**

The receiver restarts automatically.

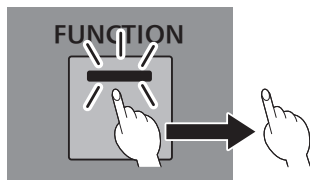
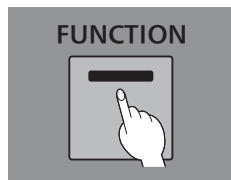

Note

- When the LED lights in red, [HDMI-CEC control] and [HDCP] settings internally set in the receiver are turned [Off]. An HDCP-incompatible device can be used.
- When the LED lights in white, the settings are not correct. Perform the procedure again.
- Press the FUNCTION button shortly and release the finger (within one second) to confirm the current state.
Red: an HDCP-incompatible device can be used.
White: an HDCP-incompatible device cannot be used.

Connecting the BQ1 touch panel

When using the BQ1 touch panel to operate an externally connected device (PC), change the settings of [PressIT Touch Function]. Configure the settings for a device connected to the TOUCH (USB) terminal on the front.

[Device operation mode settings] - submenu screen

Device operation mode settings		
Auto setting	< On >	
Auto input change setting	< Off >	
PressIT Touch Function	< Off >	

■ [Auto setting]

When it is set to [On], device operation mode is automatically set when a device is connected to the [TOUCH (USB)] terminal.

Device operation mode is canceled by the following operation:

- The device is disconnected from TOUCH (USB) terminal.
- The input is switched to another.
- [Touch screen settings] - [Touch screen] is set to [Off].

■ [Auto input change setting]

The input is switched to the specified input when device operation mode is set

Off (no switching) / HDMI1 / HDMI2 / HDMI3 / DisplayPort / DVI-D / PC

■ [PressIT Touch Function]

Specifies the switching timing of the device operation mode.

[Off]: Switches the mode with normal operation.

[On]: Switches the mode at the PressIT switching timing.

Note

- Select [On] when connecting the touch panel to the PC via PressIT.
- This setting is displayed when the main software version is 2.2000 or later.

Installing the Receiver

Components for receiver mounting bracket

Check the following parts are included.

Base bracket (A-1).....1
(DPVF3503ZA/X1)

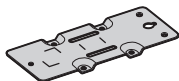

Connecting bracket C (A-4).....1
(DPVF3506ZA/X1)

Used to install on the projector.



Knurled screw (C-1).....2
(DPVF3509ZA/X)

(M4×5)



Connecting bracket A (A-2).....1
(DPVF3505ZA/X1)

Used to install on the display.



Sheet A (B-1).....1
(DPVF3507ZA/X1)

(30×12 mm)



Screw (C-2).....6
(DPVF3510ZA/X1)

(M4×5)



Connecting bracket B (A-3).....1
(DPVF3504ZA/X1)

Used to install on the display.



Sheet B (B-2).....3
(DPVF3508ZA/X1)

(24×20 mm)



Screw (C-3).....2
(DPVF3511ZA/X1)

(M3×8)



Mounting the base bracket (common)

- 1 Place the base bracket (A-1) aligning it with the 4 screw holes on the bottom surface of the receiver.
- 2 Fix the base bracket (A-1) with 4 screws (C-2).

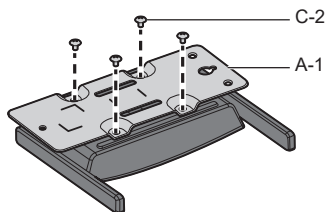

The base bracket can be mounted in either vertical or horizontal direction.

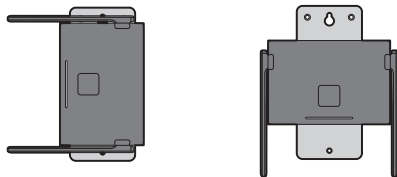

Installing on the ceiling or wall

- 1 Mount the base bracket (A-1) to the receiver.**
- 2 Fix the receiver to the ceiling or wall with 2 screws.**

Use screws (commercially available) of the appropriate type and length according to the ceiling or wall to be installed. (Recommended size: M4)

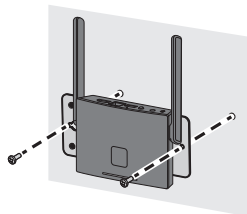

Installing on the display

- 1 Mount the base bracket (A-1) to the receiver.**
- 2 Fix the connecting bracket A (A-2) to the base bracket (A-1) with 2 screws (C-2).**

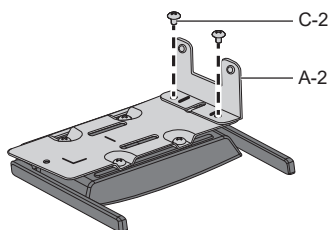

- 3 Fix the connecting bracket B (A-3) to the connecting bracket A (A-2) with 2 knurled screw (C-1).**

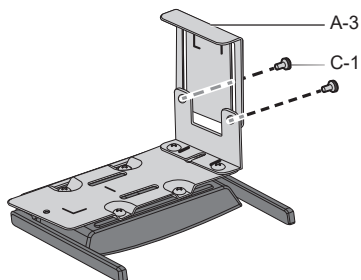

4 Attach 1 sheet A (B-1) and 3 sheets B (B-2) to the brackets along the marking-off lines

Remove the double-sided taped release paper from those sheets and attach them to the brackets. Then remove the protection films.

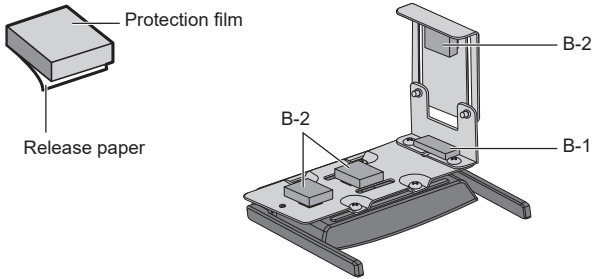

5 Install the receiver on the display.

- ① Loosen 2 knurled screws (C-1).
- ② Hang the tip of the mounting bracket on the display.
- ③ Hold the display with the mounting bracket to install the receiver.
- ④ Tighten 2 knurled screws (C-1).

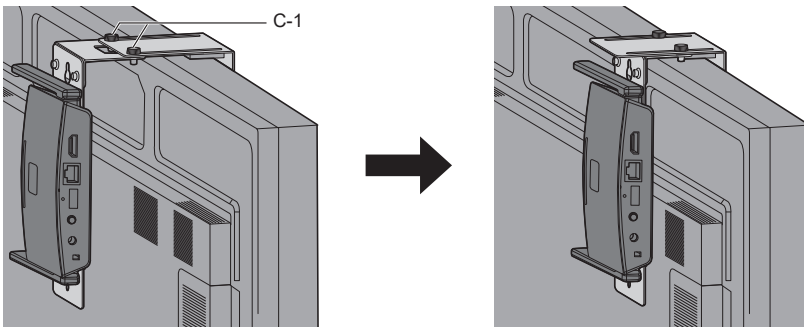

Recommended example for installing on the projector professional model

1 Mount the base bracket (A-1) to the receiver.

2 Remove 2 round covers from the side of the projector.

Screw holes for installing the receiver are exposed.

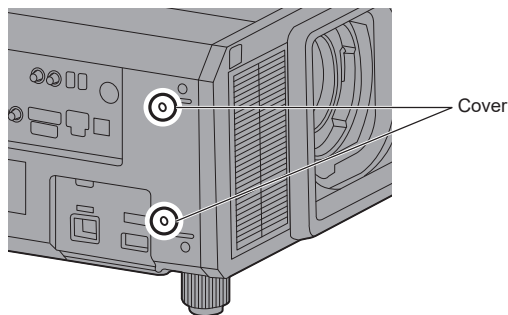

3 Install the receiver on the projector with 2 screws (C-3).

Install the receiver with marking "UP" of the base bracket facing upward.

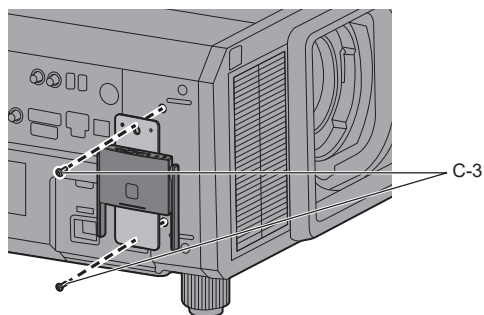

Note

- The illustrations show the PT-RZ21K model.
- Depending on the model of projector, the above method may not be used for installation.

Recommended example for installing on the projector system model

- 1** Mount the base bracket (A-1) to the receiver.
- 2** Fix the connecting bracket C (A-4) to the base bracket (A-1) with 2 screws (C-2).

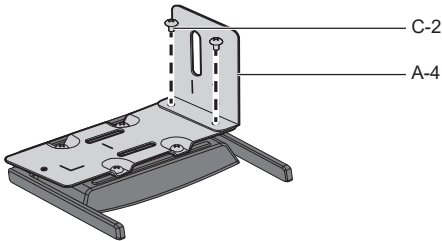

- 3** Remove the adjuster on the bottom surface of the projector by turning it counterclockwise.

Install the receiver at a position that does not block the air inlet and air outlet. Be careful not to allow the receiver to hit the AC cord. Also, the receiver should be installed in such a direction that the cable to be connected does not interfere with the cable of the projector.

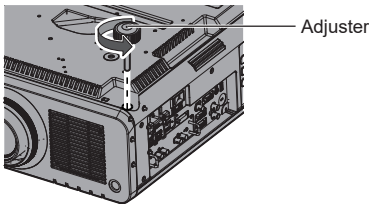

- 4** Pass the adjuster through the long hole of the connecting bracket C (A-4).
- 5** While pressing the connecting bracket C (A-4) against the projector so that the connecting bracket is stabilized, tighten the adjuster to fix it.

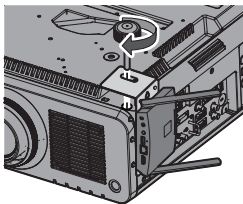

Note

- The illustrations show the PT-RCQ10 model.
- Depending on the model of projector, the above method may not be used for installation.

When installing the receiver to the models shown below, mount it at specified positions for safety.

- PT-FRZ60 series (PT-FRZ60 / PT-FRZ50 / PT-FRZ55)
- PT-RZ570 series (PT-RZ570 / PT-RZ575)

Setting on a desk or floor

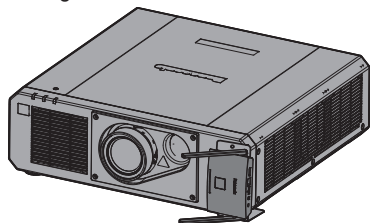

Mounting on a ceiling

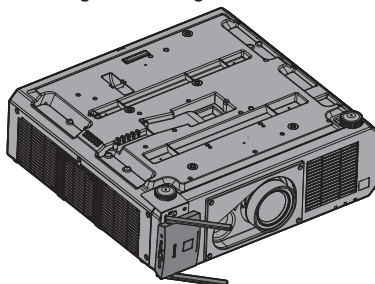

- PT-MZ16K series (PT-MZ16K / PT-MZ13K / PT-MZ10K)

Setting on a desk or floor

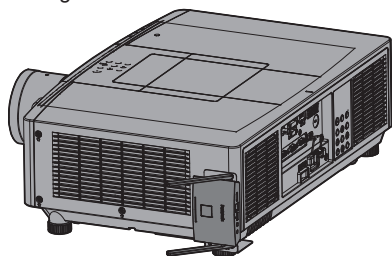

Mounting on a ceiling

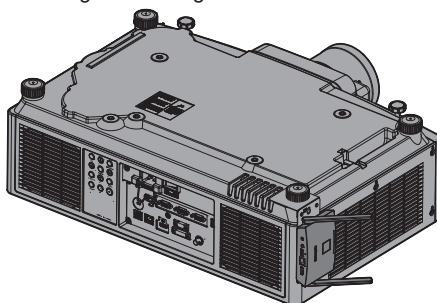

- PT-MZ770 series (PT-MZ770 / PT-MW730)
- PT-MZ670 series (PT-MZ670 / PT-MW630 / PT-MZ570 / PT-MW530)

Setting on a desk or floor

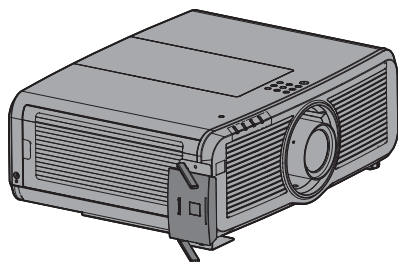

Mounting on a ceiling

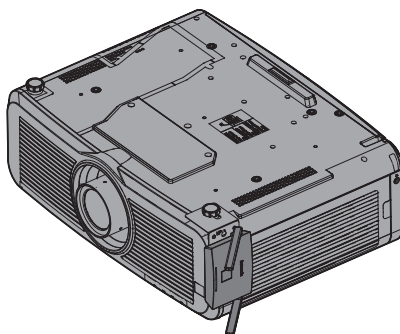

Recommended example for installing on the projector portable model

Use a commercially sold fixing band with a width of 25 mm or less.

1 Mount the base bracket (A-1) to the receiver.

2 Attach 2 sheets B (B-2) to the bracket along the marking-off lines

Remove the double-sided taped release paper from those sheets and attach them to the brackets. Then remove the protection films.

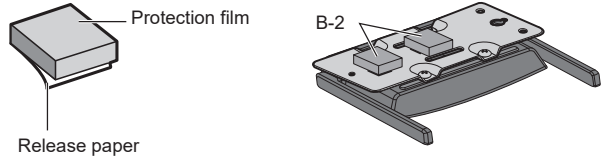

3 Pass the band through the slit of the base bracket (A-1).

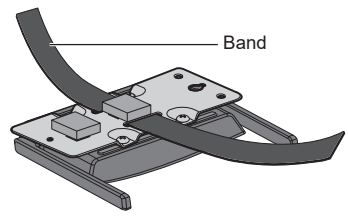

4 Install the receiver on the ceiling-hanging base bracket of the projector.

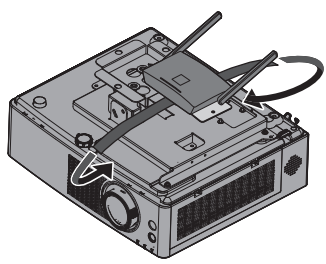

5 Wrap the band through the ceiling-hanging base bracket and fix the receiver.

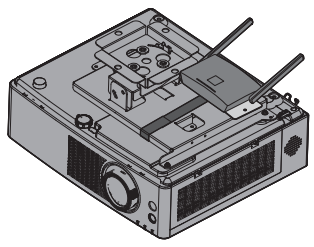

Note

- The illustrations show the PT-VMZ60 model.
- Depending on the model of projector, the above method may not be used for installation.

Image Signals Supported by This Product

■ Image output resolution of the receiver

WPS Receiver (TY-WPR1 / TY-WPR1W) WPS Receiver board (TY-SB01WP)	
HDMI output signals	
3840 x 2160@30Hz RGB	1920 x 1080@24Hz
1920 x 1080@60Hz RGB	1280 x 1024@60Hz
4096 x 2160@24Hz	1280 x 960@60Hz
3840 x 2160@30Hz	1280 x 800@60Hz
3840 x 2160@25Hz	1280 x 720@60Hz
3840 x 2160@24Hz	1280 x 720@50Hz
1920 x 1080@60Hz	1024 x 768@60Hz
1920 x 1080@50Hz	800 x 600@60Hz

■ Image input resolution of the transmitter

WPS Transmitter (TY-WPB1 / TY-WPB1W)	WPS USB-C Transmitter (TY-WPBC1 / TY-WPBC1W)
HDMI input-supported signals	USB-C input-supported signals
1920 x 1080@60Hz	1920 x 1080@60Hz
1920 x 1080@50Hz	1920 x 1080@50Hz
1920 x 1080@30Hz	1920 x 1080@30Hz
1280 x 720@60Hz	1280 x 720@60Hz
1280 x 720@50Hz	1280 x 720@50Hz

Troubleshooting

Symptoms	Checks	Page
Pairing does not start by connecting the transmitter to the USB terminal of the receiver.	<ul style="list-style-type: none"> ● Is the mode switch of the transmitter on the STD side? 	20
Pairing does not start by connecting the USB memory where the pairing file is stored to the USB terminal of the transmitter.	<ul style="list-style-type: none"> ● Is the mode switch of the transmitter on the EXT side? 	21
Touch information is not sent to the PC although the USB cable of the touch module is connected to the receiver.	<ul style="list-style-type: none"> ● Is the mode switch of the transmitter on the STD side? ● Some devices do not support the touch module. 	9
Forgot the login password for the Web setting screen.	<ul style="list-style-type: none"> ● After activating the receiver, press and hold the reset button for 5 seconds or more. The password is initialized. 	9
The main LED and sub LED of the transmitter do not light up properly.	<ul style="list-style-type: none"> ● Power supplied to the transmitter may be insufficient. Change the power source for the transmitter. 	13
HDMI-CEC function does not work.	<ul style="list-style-type: none"> ● When power is supplied from the USB terminal of the display or projector to the receiver, the power may become insufficient when the power is turned off. Change the power source for the receiver. 	12
When the transmitter is connected to the PC, images on the PC are distorted.	<ul style="list-style-type: none"> ● This phenomenon occurs when the PC judges the supported signal information of the transmitter and changes the resolution of the images to the most appropriate one. This is not a malfunction. 	—
When the resolution of PC images is changed while sending images of PC, etc., the images are distorted or non-signal images are displayed.	<ul style="list-style-type: none"> ● This phenomenon occurs when the signal from PC is changed. This is not a malfunction. 	—

Specifications

Receiver

Model No.	TY-WPR1 / TY-WPR1W
Product name	WPS Receiver
Video output	HDMI × 1 (HDCP1.4)
Output resolution	1920 x 1080/60p, 3840 x 2160/30p (max.)
Number of simultaneous connections	32
Wireless communication standard	IEEE802.11a/n/ac Bluetooth (GFSK, π/4-DQPSK, 8DPSK)
Data rate wireless	867 Mbps (max.)
Frequency band	5 GHz (5.150 GHz to 5.250 GHz)
Security	WPA/WPA2/WPA3 (WPA3-Enterprise is not supported)
Reachable distance	Up to 30 m (Locations with good visibility and radio wave conditions)
FUNCTION LED	
White blinking	Pairing in progress
White illumination	Pairing complete
LAN terminal	RJ45 × 1 10BASE-T/100BASE-TX/1000BASE-T supported
USB terminal	USB connector × 1, Type-A
Power supply	DC 5 V/2 A
Dimensions (W × H × D)	120 mm × 26 mm × 81 mm / 4.71" × 1.03" × 3.19" (excluding antennas)
Mass	Approx. 181 g / 0.4 lbs
Operating condition	Temperature: 0 °C to 35 °C (32 °F to 95 °F) Humidity: 20 % to 80 % (no condensation)
Storage condition	Temperature: -20 °C to 60 °C (-4 °F to 140 °F) Humidity: 20 % to 80 % (no condensation)

Receiver board

Model No.	TY-SB01WP
Product name	Wireless Presentation System Receiver Board
Video output	HDMI × 1 (HDCP1.4)
Output resolution	1920 x 1080/60p, 3840 x 2160/30p (max.)
Number of simultaneous connections	32
Wireless communication standard	IEEE802.11a/n/ac Bluetooth (GFSK, π/4-DQPSK, 8DPSK)
Data rate wireless	867 Mbps (max.)
Frequency band	5 GHz (5.150 GHz to 5.250 GHz)
Security	WPA/WPA2/WPA3 (WPA3-Enterprise is not supported)
Reachable distance	Up to 30 m (Locations with good visibility and radio wave conditions)
FUNCTION LED	
White blinking	Pairing in progress
White illumination	Pairing complete
LAN terminal	RJ45 × 1 10BASE-T/100BASE-TX/ 1000BASE-T supported
USB terminal	USB connector × 1, Type-A
Dimensions (W × H × D)	82 mm × 25 mm × 122 mm / 3.22" × 0.99" × 4.78" (excluding antennas)
Mass	Approx. 125 g / 0.3 lbs

Transmitter

Model No.	TY-WPB1 / TY-WPB1W	TY-WPBC1 / TY-WPBC1W
Product name	WPS Transmitter	WPS USB-C Transmitter
Video input	HDMI × 1 (HDCP1.4)	USB Type-C × 1 (HDCP1.4, DisplayPort Alt Mode)
Input resolution	1920 x 1080/60p (max.)	
Wireless communication standard	IEEE802.11ac	
Data rate wireless	433 Mbps (max.)	
Frequency band	5 GHz (5.150 GHz to 5.250 GHz)	
Security	WPA/WPA2/WPA3 (WPA3-Enterprise is not supported)	
Reachable distance	Up to 30 m (Locations with good visibility and radio wave conditions)	
Main LED		
White blinking	Standby (no signal input), pairing in progress	
White illumination	Standby or pairing complete	
Red blinking	Connecting	
Red illumination	Operation disabled	
Green blinking	Image being displayed (no signal input)	
Green illumination	Image being displayed	
Blue blinking	Fixed mode (no signal input)	
Blue illumination	Fixed mode	
Sub LED		
Green illumination	Multi-screen mode	
USB terminal	USB connector × 1, Type-A	
Power supply	DC 5 V/0.9 A	
Dimensions (W × H × D)	51 mm × 21 mm × 73 mm / 2.00" × 0.80" × 2.86" (excluding cables) 51 mm × 21 mm × 283 mm / 2.00" × 0.80" × 11.12" (including cables)	51 mm × 26 mm × 73 mm / 2.00" × 1.00" × 2.86" (excluding cables) 51 mm × 26 mm × 178 mm / 2.00" × 1.00" × 6.98" (including cables)
Mass	Approx. 110 g / 0.3 lbs	
Operating condition	Temperature: 0 °C to 35 °C (32 °F to 95 °F) Humidity: 20 % to 80 % (no condensation)	
Storage condition	Temperature: -20 °C to 60 °C (-4 °F to 140 °F) Humidity: 20 % to 80 % (no condensation)	

Software License

This product incorporates the following software:

- (1) the software developed independently by or for Panasonic Connect Co., Ltd.,
- (2) the software owned by third party and licensed to Panasonic Connect Co., Ltd.,
- (3) the software licensed under the GNU General Public License, Version 2.0 (GPL V2.0),
- (4) the software licensed under the GNU LIBRARY General Public License, Version 2.0 (LGPL V2.0),
- (5) the software licensed under the GNU LESSER General Public License, Version 2.1 (LGPL V2.1), and/or
- (6) open source software other than the software licensed under the GPL V2.0, LGPL V2.0 and/or LGPL V2.1.

The software categorized as (3) - (6) are distributed in the hope that it will be useful, but WITHOUT ANY WARRANTY, without even the implied warranty of MERCHANTABILITY or FITNESS FOR A PARTICULAR PURPOSE. For details, see the license conditions displayed by selecting [Software licenses], following the specified operation from the Web setting screen of this product.

At least three (3) years from delivery of this product, Panasonic Connect Co., Ltd. will give to any third party who contacts us at the contact information provided below, for a charge no more than our cost of physically performing source code distribution, a complete machine-readable copy of the corresponding source code covered under GPL V2.0, LGPL V2.0, LGPL V2.1 or the other licenses with the obligation to do so, as well as the respective copyright notice thereof.

Contact Information:

oss-cd-request@gg.jp.panasonic.com

Trademark Credit

- HDMI, High-Definition Multimedia Interface and the HDMI Logo are trademarks or registered trademarks of HDMI Licensing Administrator, Inc. in the United States and other countries.
- USB Type-C and USB-C are trademarks or registered trademarks of USB Implementers Forum.
- PressIT is a trademark of Panasonic Holdings Corporation.
- Bluetooth and the logo are trademarks of Bluetooth SIG, Inc. Panasonic Connect Co., Ltd. uses them under license.
- Microsoft, Windows, Internet Explorer and Microsoft Edge are the registered trademarks or trademarks of Microsoft Corporation in the United States and/or other countries.
- Safari is a trademark of Apple Inc., registered in the United States and other countries.
- Google and Android are trademarks of Google LLC.
- Firefox is a trademark of the Mozilla Foundation in the United States and other countries.
- Miracast™ is a trademark of Wi-Fi Alliance.

Even if no special notation has been made of company or product trademarks, these trademarks have been fully respected.

FCC STATEMENT

This equipment has been tested and found to comply with the limits for a Class B digital device, pursuant to Part 15 of the FCC Rules. These limits are designed to provide reasonable protection against harmful interference in a residential installation. This equipment generates, uses and can radiate radio frequency energy and, if not installed and used in accordance with the instructions, may cause harmful interference to radio communications.

However, there is no guarantee that interference will not occur in a particular installation. If this equipment does cause harmful interference to radio or television reception, which can be determined by turning the equipment off and on, the user is encouraged to try to correct the interference by one or more of the following measures:

- Reorient or relocate the receiving antenna.
- Increase the separation between the equipment and receiver.
- Connect the equipment into an outlet on a circuit different from that to which the receiver is connected.
- Consult the dealer or an experienced technician for help.

FCC CAUTION:

To assure continued compliance, follow the attached installation instructions and use only the provided power supply cord. Any changes or modifications not expressly approved by Panasonic Corp. of North America could void the user's authority to operate this device.

FCC RF Exposure Warning:

- **This transmitter complies with FCC radiation exposure limits set forth for an uncontrolled environment for mobile use with minimum 8 inches (20 cm) spacing requirement between transmitter and all person's body (excluding extremities of hands, wrist and feet) during wireless modes of operation.**

<Only for wireless LAN if capable of transmission in the 5.150 to 5.250 GHz frequency band>

This product is restricted to indoor use due to its operation in the 5.150 to 5.250 GHz frequency range.

Supplier's Declaration of Conformity

Model No.

TY-WPR1, TY-WPB1, TY-WPBC1, TY-SB01WP

Responsible Party:

Panasonic Corporation of North America
Two Riverfront Plaza, Newark, New Jersey
07102-5490

Contact Source:

Panasonic Connect North America
1-877-655-2357

General Contact:

<http://shop.panasonic.com/support>

This device complies with Part 15 of the FCC Rules. Operation is subject to the following two conditions: (1) This device may not cause harmful interference, and (2) this device must accept any interference received, including interference that may cause undesired operation.

Disposal of Old Equipment

Only for European Union and countries with recycling systems



This symbol on the products, packaging, and/or accompanying documents mean that used electrical and electronic products must not be mixed with general household waste.

For proper treatment, recovery and recycling of old products, please take them to applicable collection points in accordance with your national legislation.

By disposing of them correctly, you will help to save valuable resources and prevent any potential negative effects on human health and the environment.

For more information about collection and recycling, please contact your local authority.

Penalties may be applicable for incorrect disposal of this waste, in accordance with national legislation.

Notice (U.S.A. only)

Disposal may be regulated in your community due to environmental considerations. For disposal or recycling information, please visit Panasonic website:

<https://holdings.panasonic/global/corporate/sustainability.html>

or call 1-888-769-0149.

Customer's Record

The model number and serial number of this product may be found on its rear panel. You should note this serial number in the space provided below and retain this book, plus your purchase receipt, as a permanent record of your purchase to aid in identification in the event of theft or loss, and for Warranty Service purposes.

Model Number

Serial Number

Panasonic Connect North America

Unit of Panasonic Corporation of North America

Executive Office :

Two Riverfront Plaza, Newark, New Jersey 07102

Manufactured by:

Panasonic Connect Co., Ltd.

4-1-62 Minoshima, Hakata-ku, Fukuoka 812-8531, Japan

Importer:

Panasonic Connect Europe GmbH

Hagenauer Strasse 43, 65203 Wiesbaden, Germany

Authorized Representative in EU:

Panasonic Connect Europe GmbH

Panasonic Testing Centre

Winsbergring 15, 22525 Hamburg, Germany

Importer for UK:

Panasonic Connect UK,

a branch of Panasonic Connect Europe GmbH,

Maxis 2, Western Road, Bracknell, Berkshire, RG12 1RT

Panasonic Connect Co., Ltd.

4-1-62 Minoshima, Hakata-ku, Fukuoka 812-8531, Japan

Web Site: <https://panasonic.net/cns/prodisplays/>

© Panasonic Connect Co., Ltd. 2022

English