

Panasonic®

Operating Instructions <Basics>

Installation Instructions provided

HD Communication Camera

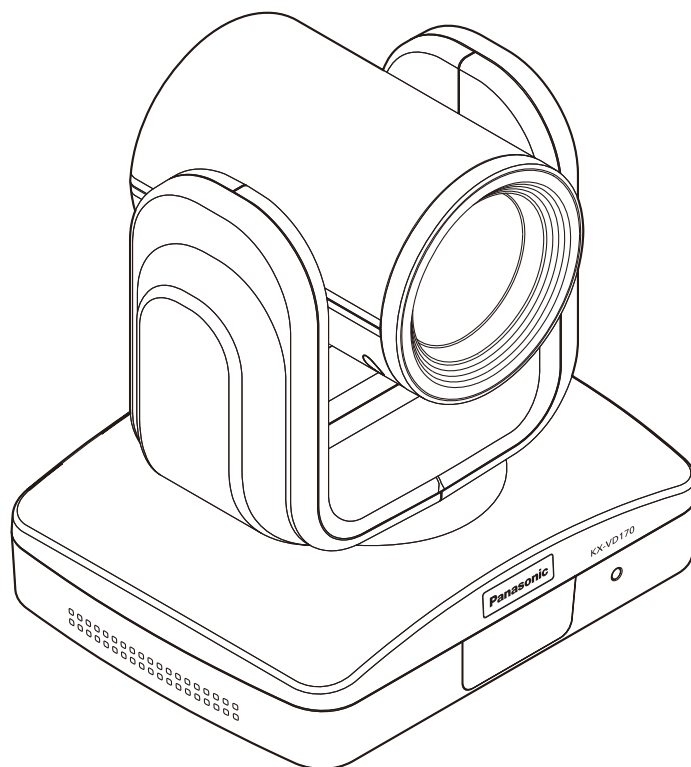

Model No. **KX-VD170, KX-VD170SX**



Before operating this product, please read the instructions carefully and save this manual for future use.

For instructions on how to operate this HD Communication Camera and how to establish its settings, refer to the operating instructions of the HD Visual Communication Unit to be connected.

Safety precautions

	CAUTION RISK OF ELECTRIC SHOCK DO NOT OPEN	
CAUTION: TO REDUCE THE RISK OF ELECTRIC SHOCK, DO NOT REMOVE COVER (OR BACK). NO USER-SERVICEABLE PARTS INSIDE. REFER SERVICING TO QUALIFIED SERVICE PERSONNEL.		



The lightning flash with arrowhead symbol, within an equilateral triangle, is intended to alert the user to the presence of uninsulated "dangerous voltage" within the product's enclosure that may be of sufficient magnitude to constitute a risk of electric shock to persons.



The exclamation point within an equilateral triangle is intended to alert the user to the presence of important operating and maintenance (servicing) instructions in the literature accompanying the appliance.

For CANADA

CAN ICES-3(A)/NMB-3(A)

WARNING:

- **To prevent fire or electric shock hazard, do not expose this apparatus to rain or moisture.**
- **The apparatus should not be exposed to dripping or splashing and no objects filled with liquids, such as vases, should be placed on the apparatus.**
- **The mains plug or an appliance coupler shall remain readily operable.**
- **The connections should comply with local electrical code.**

■ DO NOT REMOVE PANEL COVERS BY UNSCREWING.

To reduce the risk of electric shock, do not remove the covers. No user serviceable parts inside. Refer servicing to qualified service personnel.

This is a class A product. In a domestic environment this product may cause radio interference in which case the user may be required to take adequate measures.

For U.S.A.

FCC Note:

This equipment has been tested and found to comply with the limits for a class A digital device, pursuant to Part 15 of the FCC Rules. These limits are designed to provide reasonable protection against harmful interference when the equipment is operated in a commercial environment. This equipment generates, uses, and can radiate radio frequency energy, and if not installed and used in accordance with the instruction manual, may cause harmful interference to radio communications. Operation of this equipment in a residential area is likely to cause harmful interference in which case the user will be required to correct the interference at his own expense.

FCC Caution:

To assure continued compliance, (example -use only shielded interface cables when connecting to computer or peripheral devices). Any changes or modifications not expressly approved by the party responsible for compliance could void the user's authority to operate this equipment.

CAUTION:

Before attempting to connect or operate this product, please read the label on the bottom.

For U.S.A.

The model number and serial number of this product may be found on the surface of the unit. You should note the model number and serial number of this unit in the space provided and retain this book as a permanent record of your purchase to aid identification in the event of theft.

Model No. _____
 Serial No. _____

CAUTION:

In order to maintain adequate ventilation, do not install or place this unit in a bookcase, built-in cabinet or any other confined space. To prevent risk of electric shock or fire hazard due to overheating, ensure that curtains and any other materials do not obstruct the ventilation.

For use only with power supply Panasonic, PNLV6508.

UL listed model No.: KX-VD170

 indicates safety information.

Safety precautions

IMPORTANT SAFETY INSTRUCTIONS

Read these operating instructions carefully before using the unit. Follow the safety instructions on the unit and the applicable safety instructions listed below. Keep these operating instructions handy for future reference.

- 1) Read these instructions.
- 2) Keep these instructions.
- 3) Heed all warnings.
- 4) Follow all instructions.
- 5) Do not use this apparatus near water.
- 6) Clean only with dry cloth.
- 7) Do not block any ventilation openings. Install in accordance with the manufacturer's instructions.
- 8) Do not install near any heat sources such as radiators, heat registers, stoves, or other apparatus (including amplifiers) that produce heat.
- 9) Protect the power cord from being walked on or pinched particularly at plugs, convenience receptacles, and the point where they exit from the apparatus.
- 10) Only use attachments/accessories specified by the manufacturer.
- 11) Use only with the tripod, bracket, or table specified by the manufacturer.
- 12) Unplug this apparatus during lightning storms or when unused for long periods of time.
- 13) Refer all servicing to qualified service personnel. Servicing is required when the apparatus has been damaged in any way, such as power-supply cord or plug is damaged, liquid has been spilled or objects have fallen into the apparatus, the apparatus has been exposed to rain or moisture, does not operate normally, or has been dropped.

 indicates safety information.

Declaration of Conformity
with the requirements of Technical Regulation on the Restriction Of the use of certain Hazardous Substances
in Electrical and Electronic Equipment
(adopted by Order №1057 of Cabinet of Ministers of Ukraine)

The Product is in conformity with the requirements of Technical Regulation on the Restriction Of the use of certain Hazardous Substances in electrical and electronic equipment (TR on RoHS).

The content of hazardous substance with the exemption of the applications listed in the Annex №2 of TR on RoHS:

1. Lead (Pb) – not over 0,1wt % or 1000wt ppm;
2. Cadmium (Cd) – not over 0,01wt % or 100wt ppm;
3. Mercury (Hg) – not over 0,1wt % or 1000wt ppm;
4. Hexavalent chromium (Cr⁶⁺) – not over 0,1wt % or 1000wt ppm;
5. Polybrominated biphenyls (PBBs) – not over 0,1wt % or 1000wt ppm;
6. Polybrominated diphenyl ethers (PBDEs) – not over 0,1wt % or 1000wt ppm.

Safety precautions

Disposal of Old Equipment

Only for European Union and countries with recycling systems



This symbol on the products, packaging, and/or accompanying documents means that used electrical and electronic products must not be mixed with general household waste. For proper treatment, recovery and recycling of old products, please take them to applicable collection points in accordance with your national legislation.

By disposing of them correctly, you will help to save valuable resources and prevent any potential negative effects on human health and the environment.

For more information about collection and recycling, please contact your local municipality. Penalties may be applicable for incorrect disposal of this waste, in accordance with national legislation.



Information on disposal in other countries outside the European Union

These symbols are only valid in the European Union. If you wish to discard these items, please contact your local authorities or dealer and ask for the correct method of disposal.

For users in the United Kingdom

FOR YOUR SAFETY, PLEASE READ THE FOLLOWING TEXT CAREFULLY.

This appliance is supplied with a moulded three-pin mains plug for your safety and convenience. Should the fuse need to be replaced, please ensure that the replacement fuse is of the same rating and that it is approved by ASTA or BSI to BS1362.

Check for the ASTA mark  or the BSI mark  on the body of the fuse.

If the plug contains a removable fuse cover, you must ensure that it is refitted when the fuse is replaced. If you lose the fuse cover, the plug must not be used until a replacement cover is obtained. A replacement fuse cover can be purchased from your local Panasonic dealer.

IF THE FITTED MOULDED PLUG IS UNSUITABLE FOR THE AC OUTLET IN YOUR PREMISES, THEN THE FUSE SHOULD BE REMOVED AND THE PLUG CUT OFF AND DISPOSED OF SAFELY. THERE IS A DANGER OF SEVERE ELECTRICAL SHOCK IF THE CUT-OFF PLUG IS INSERTED INTO ANY 13 AMP SOCKET.

How to replace the fuse:

Open the fuse compartment with a screwdriver and replace the fuse and fuse cover.

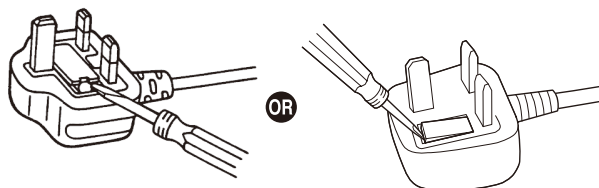

 indicates safety information.

Contents

Safety precautions	2	Connections	15
Before use	6	Connections to the HD Visual Communication Unit and AC adaptor	15
Overview	6	How to turn the power on and off	16
Concerning the HD Visual Communication Unit	6	Turning the power on	16
Trademarks and registered trademarks	6	Turning the power off	16
About copyright and licence	6	Concerning the mode transitions	16
Disclaimer of warranty	6	Factory setting	17
Characteristics	7	Factory settings for the setting items	17
Standard accessories	7	Troubleshooting	18
Optional accessories	7	Appearance	21
Installation precautions	8	Specifications	22
Operating precautions	10		
The remote control through function	12		
Parts and their functions	13		
Stand-alone installation procedure	14		
When installing the unit on a desk	14		
When mounting the unit on a tripod	14		

How the model's Operating Instructions manuals are configured

- Before installing the unit, be sure to read this document to ensure that the unit is installed correctly.
- This manual explains how to install the unit.
For details on how to operate the unit and select its settings, refer to the operating instructions of the HD Visual Communication Unit to be connected.
To read PDF files, you will need Adobe® Reader® software or Adobe Acrobat Reader® software which is available from Adobe.

Before use

■ Overview

- This unit is a full HD camera integrated with a pan-tilt head and featuring a 1/2.8-type full HD CMOS sensor and digital signal processor (DSP).
- This unit is designed to be used exclusively with Panasonic HD Visual Communication Units.

Compatible HD Visual Communication Units:

KX-VC1000, KX-VC1300, KX-VC1600, KX-VC2000,
KX-VC1300A, KX-VC1600A, KX-VC1000SX,
KX-VC1300SX, KX-VC1600SX, KX-VC2000SX
Software File Version 4.52 or later

■ Concerning the HD Visual Communication Unit

The unit's operations are performed and its settings are selected using the remote controller of the HD Visual Communication Unit connected. This means that the unit can be operated only when it is connected to the HD Visual Communication Unit and it is operating normally. For more details, refer to the operating instructions which came with the HD Visual Communication Unit concerned.

■ Trademarks and registered trademarks

- The terms HDMI, HDMI High-Definition Multimedia Interface, and the HDMI Logo are trademarks or registered trademarks of HDMI Licensing Administrator, Inc.
- Adobe, Reader, and Acrobat Reader are either registered trademarks or trademarks of Adobe in the United States and/or other countries.

■ About copyright and licence

Distributing, copying, disassembling, reverse compiling and reverse engineering of the software provided with this product are all expressly prohibited. In addition, exporting any software provided with this product violating export laws is prohibited.

■ Disclaimer of warranty

IN NO EVENT SHALL Panasonic Corporation BE LIABLE TO ANY PARTY OR ANY PERSON, EXCEPT FOR REPLACEMENT OR REASONABLE MAINTENANCE OF THE PRODUCT, FOR THE CASES, INCLUDING BUT NOT LIMITED TO BELOW:

- 1 ANY DAMAGE AND LOSS, INCLUDING WITHOUT LIMITATION, DIRECT OR INDIRECT, SPECIAL, CONSEQUENTIAL OR EXEMPLARY, ARISING OUT OF OR RELATING TO THE PRODUCT;
- 2 ANY INCONVENIENCE, LOSS, OR DAMAGE CAUSED BY INAPPROPRIATE USE OR NEGLIGENT OPERATION OF THE USER;
- 3 ALL MALFUNCTIONS OR TROUBLES FROM UNAUTHORIZED DISASSEMBLE, REPAIR OR MODIFICATION OF THE PRODUCT BY THE USER, REGARDLESS OF THE CAUSE OF THE MALFUNCTION OR TROUBLE;
- 4 INCONVENIENCE OR ANY LOSS ARISING WHEN IMAGES ARE NOT DISPLAYED, DUE TO ANY REASON OR CAUSE INCLUDING ANY FAILURE OR PROBLEM OF THE PRODUCT;
- 5 ANY PROBLEM, CONSEQUENTIAL INCONVENIENCE, OR LOSS OR DAMAGE, ARISING OUT OF THE SYSTEM COMBINED BY THE DEVICES OF THIRD PARTY.

Characteristics

1/2.8-type CMOS sensor and high-performance 12× zoom lens featured

- A 1/2.8-type full HD CMOS sensor and DSP (digital signal processor) are incorporated. High-quality pictures are obtained by video processing in many different kinds of ways.
- In addition to its optical 12× zoom lens, the unit comes with a 10× digital zoom to achieve high-quality images that overflow with ambiance.

Operations can be performed by the remote controller of the HD Visual Communication Unit

The functions and settings can also be switched easily while viewing the menu screens.
(These switching operations can be performed only while the HD Visual Communication Unit is operating.)

The remote control through function allows more installation flexibility.

Since this function enables this unit to operate the HD Visual Communication Unit using this unit's remote controller signal receiver to receive signals from the HD Visual Communication Unit's remote controller, you have more flexibility in where you install this unit.

Standard accessories

Check that the following accessories are present and accounted for.

Getting Started	1	Power cable* (1.8 m {5.91 feet}) (KX-VD170)	3
AC adaptor	1	Power cable (1.8 m {5.91 feet}) (KX-VD170SX)	1

* Use the power cable that is suited to your locality.

Optional accessories

Ceiling Mount Bracket: KX-VCZ170

Installation precautions

In addition to heeding the points presented in the “Safety precautions”, observe the following precautions as well.

Ensure that the installation work complies with the technical standards governing electrical equipment.

This unit is for indoor use only.

It cannot be used outdoors.

Avoid installation in a location where the unit will be exposed to direct sunlight for extended periods or near a cooling or heating appliance.

Otherwise, deformation, discoloration, malfunctioning and/or problems in operation may result. Operate the unit where it will not be splashed or sprayed by water.

Use the unit with an installation where the unit is suspended from an overhead surface or with a stand-alone installation.

Do not use the unit on its side or tilted at an angle.

For ceiling mount, be sure to use the specified bracket and follow the operating instructions provided with the bracket to perform the work.

Notes

- When using a mounting bracket which is sold separately, refer to the operating instructions provided with it.
- Do not hold the camera head while undertaking the installation work. Doing so may cause malfunctioning.

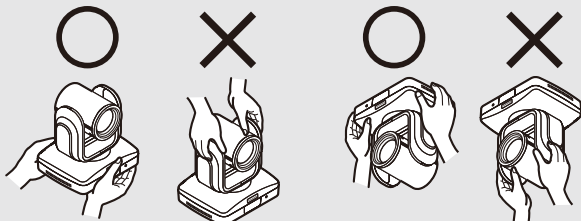

Stand-alone installation

Suspended installation

Concerning the installation location

Install the unit in a stable location which will not be susceptible to shaking. If the unit is installed in a location which is susceptible to shaking, this will cause the unit's images to shake in turn.

Install the unit after conferring in detail with your dealer.

Install the unit on a ceiling that is strong enough (such as a concrete ceiling).

If the unit is to be installed on a ceiling which is not strong enough, reinforce the ceiling sufficiently first.

Do not install or use the unit in the following kinds of locations.

- On the surface of a wall (where the unit will be installed sideways and/or where the unit will be secured to the wall using a mounting bracket)
- In locations (including places such as under the eaves of a building) where the unit would be directly exposed to rain or water
- In locations such as kitchens where there are high concentrations of steam and grease
- In outdoor locations or hot places where the temperature will exceed 40 °C {104 °F}
- In cold locations where the temperature will drop below 0 °C {32 °F}
- In locations where the humidity will exceed 85 %
- In locations where chemicals are used such as near swimming pools
- In locations that have a specific environment that is subject to an inflammable atmosphere or solvents
- At sea, in coastal areas or in locations where corrosive gas is emitted, such as volcanic regions/hot springs
- In locations where radiation, X-rays, or strong radio waves or magnetic fields are generated
- In locations where the unit would be subject to a great deal of vibration such as on board a vehicle or ship, or above a factory production line (This unit is not designed to be used in vehicles)
- In locations where the temperature is subject to sudden changes such as near the air outlet of an air conditioner or near a door which allows the outside air to come in

What to avoid to ensure that the unit will perform stably over a prolonged period

- Using the unit for a prolonged period in a location with high temperature and humidity levels will cause its parts to deteriorate and shorten its service life.
- Ensure that a cooling unit or heating unit will not blow any air directly toward the installation location.

Be sure to use the specified bracket and screws to install the unit.

Do not mount the unit by employing any methods other than those specified.

When the unit is no longer going to be used, do not leave it lying around, but be absolutely sure to dispose of it properly.

When installing, transferring or disposing of the unit, be absolutely sure to hold it by its pedestal area.

Problems may result if the camera head is held or rotated.

Do not attach a filter, hood, extender or other parts to the unit.

Installation precautions

Use the dedicated AC adaptor and power cable provided with the unit.

Connect the AC adaptor and power cable to the power inlet securely.

The power cable supplied with this unit must always be used with this unit. The unit cannot be used with a power cable which is not supplied with the unit. Neither can the power cable supplied with the unit be used with any other device.

Installing the AC adaptor

- Do not place the AC adaptor directly on a surface such as a floor or ceiling panel. An extreme danger is posed by water pooling on the surface as a result of leaking rainwater or some other reason.
Anchor the AC adaptor securely to a surface on which no water, dust, etc. will collect.
- Secure the adaptor firmly so that there will be no chance that it will fall off or fall down.
Secure it using a strength which can withstand the mass of the AC adaptor.

Power plug

If the power plug is to be connected to a power outlet located in a dusty area, remove the dust and dirt from the power plug at regular intervals as a measure to prevent tracking.

Power switch

This unit does not have a power switch. The power turns on when its power plug is connected to a power outlet. When the power is turned on, the pan, tilt, zoom and focusing operations are performed. Before proceeding with maintenance, be absolutely sure to disconnect the power plug from the power outlet.

Connecting the power cable

Be absolutely sure to connect the power cable of the AC adaptor through a circuit breaker using one of the following methods.

- (1) Connect the power cable through a power control unit.
- (2) Connect the power cable to a circuit breaker in a power distribution panel with a contact distance of 3.0 mm {1/8 inch} or more.
Use a circuit breaker which is capable of shutting off all the poles of the main power supply with the exception of the protective ground conductor.
- (3) Install the AC adaptor near the power outlet, and connect it through the power plug.

If there is a possibility of noise interference

Either wire the cables so that the power cable (ceiling light cord) of AC 100 V or more, and the signal cable are placed at least 1 m {3.3 feet} apart. Alternatively run each cable through its own metal conduit. (The metal conduits must be grounded.)

Radio signal interference

If the unit is positioned near a TV or radio transmitting antenna or a strong electrical field or magnetic field (such as that generated by a motor, transformer or power lines), its images may be distorted and/or the images may be affected by noise.

When connecting the cables, ensure that the connector areas will not be subject to any load.

Doing so may cause malfunctioning.

IMPORTANT

- **The product name and its electrical ratings are marked on its bottom panel.**

Operating precautions

Shoot under the proper lighting conditions.

To produce pictures with eye-pleasing colors, shoot under the proper lighting conditions.
Adjust the white balance manually if necessary.

To ensure a stable performance in the long term

Using the unit for prolonged periods in locations where the temperature and humidity levels are high will cause its parts to deteriorate, resulting in a reduction of its service life.
(Recommended temperature: Max. 35 °C {95 °F})
Ensure that a cooling unit or heating unit will not blow any air directly toward the installation location.

Image persistence on the CMOS sensor color filters

If parts of the CMOS sensor are exposed continuously to spotlights or other bright lights, the color filters inside the CMOS sensor will deteriorate, and the parts concerned may become discolored.

Do not point the camera at strong lights.

When parts of the CMOS sensor are exposed to spotlights or other strong lights, blooming (a phenomenon where the edges of strong lights become blurred) may occur.

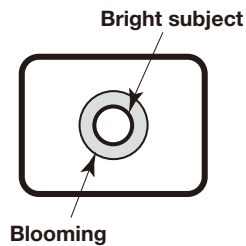

Concerning the color reproduction of CMOS sensors

Depending on the color tones of the subjects, the color reproduction may deteriorate: This is normal and not indicative of any trouble.

What happens with high-brightness subjects

Flare may occur if an extremely bright light source is pointed at the lens. In a case like this, change the angle or take some other remedial action.

Operating temperature range

Avoid using the unit in cold locations where the temperature drops below 0 °C {32 °F} or hot locations where the temperature rises above 40 °C {104 °F} since these temperatures downgrade the picture quality and adversely affect the internal parts.

Turn off the power before connecting or disconnecting the cables.

Always be sure to turn off the power before connecting or disconnecting the cables.

Keep away from flames and sparks.

Otherwise, fire may result.

Operating precautions

Handle the unit carefully.

Do not drop the unit or subject it to strong impact or vibration. Doing so may cause the unit to malfunction.

When the unit is not in use

Turn off the unit's power when it is not in use.

When the unit is no longer going to be used, do not leave it lying around, but be absolutely sure to dispose of it properly.

Do not touch the optical system parts.

Under no circumstances must they be touched.

In the unlikely event that they have become dusty, remove the dust by using a camera blower or by wiping them gently with a lens cleaning paper.

Do not allow foreign matter to make contact with the rotating parts.

Otherwise, trouble may be caused.

Keep the unit away from water.

Avoid all contact with water. Operate the unit where it will not be splashed or sprayed by water. Otherwise, problems may occur.

Maintenance

Be sure to unplug the power cable before proceeding with maintenance.

Otherwise, you may injure yourself.

Wipe the surfaces using a soft dry cloth. Avoid all contact with benzene, paint thinners and other volatile substances, and avoid using these substances. Otherwise, this may result in the deformation or discoloration of the unit.

Do not turn the camera head by hand.

Turning the camera head by hand may cause the unit to malfunction.

Use the unit in an environment with minimal moisture and dust.

Avoid using the unit in an environment with high concentration of moisture or dust since these conditions will damage the internal parts.

Disposal of the unit

When the unit has reached the end of its service life and is to be disposed of, ask a qualified contractor to dispose of the unit properly in order to protect the environment.

When using the automatic functions

- When using the automatic white balance setting (auto tracking white adjustment) function under fluorescent lights, the white balance may vary.
- In some situations, it may be hard to focus at the auto setting. In cases like this, select the manual setting, and focus manually.

Zooming and focusing

When the focus is set manually, out-of-focusing may occur during zooming.

After zooming, if necessary, either adjust the focus or set the focus to auto.

When using the focus at the manual setting, proceed with zooming after setting the focus position at the Tele end where the focusing accuracy is higher.

(However, if the distance from the unit to the subject is less than 1 m {3.3 feet}, the subject may shift out of focus at the Wide end.)

If zooming is performed to the Tele end after having adjusted the focus at the Wide end, out-of-focusing may occur.

Concerning the home position

The 'home position' refers to the position to which the lens moves first when the unit's power has been turned on.

The home position settings (position, brightness and white balance) are the same as the preset 5 settings. To change any of the home position settings, register them in preset 5.

Power switch

This product has no power switch. When disconnecting this product from the power supply, unplug the power cable. Install the unit near a power outlet so that the power cable can be plugged and unplugged easily. If it is hard to unplug the power cable due to the installation conditions, connect the power cable of this unit to the AC outlet via the circuit breaker of a distribution board or to the AC inlet socket of a power supply control unit.

Power cable

The accessory power cable is to be used only with this unit. Do not use it for any other devices. Similarly, do not use the power cables of other devices with this unit.

Markings

See the bottom side of the unit for various markings related to the unit, including those related to the identification and power supply of the unit.

The remote control through function

This unit is provided with a remote control through function. This function is used when this unit is installed apart from the HD Visual Communication Unit so that the HD Visual Communication Unit can be operated using this unit's remote controller signal receiver to receive signals from the remote controller.

● Regular remote control operations

The signals of the remote controller are received directly by the receiver of the HD Visual Communication Unit, and the operations corresponding to the signals are performed. (The receivers of the camera are not used in cases like this.)

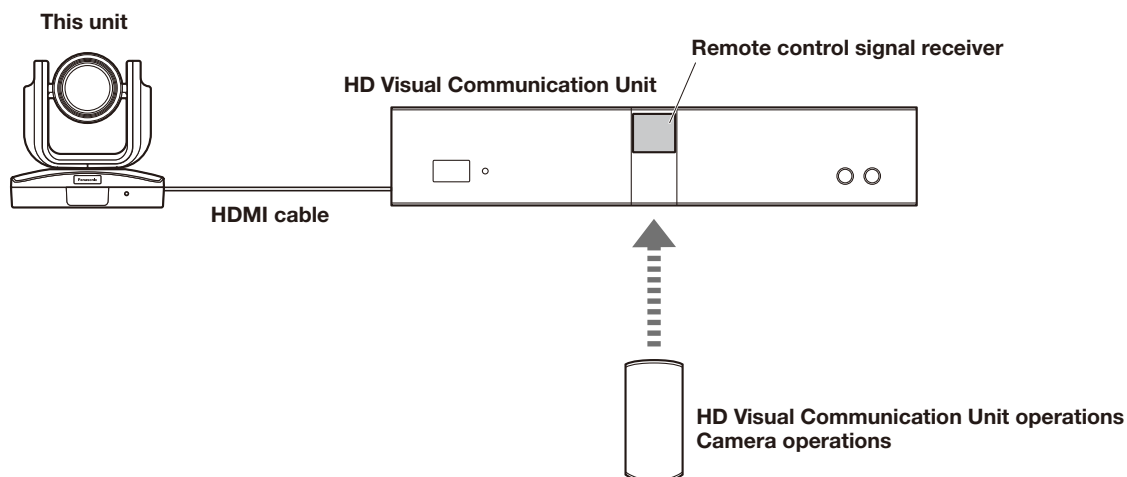

● Remote controller operations using the remote control through function

The remote controller signal receiver of this unit receives the signals from the remote controller. The HD Visual Communication Unit and this unit are operated via the HDMI cable.

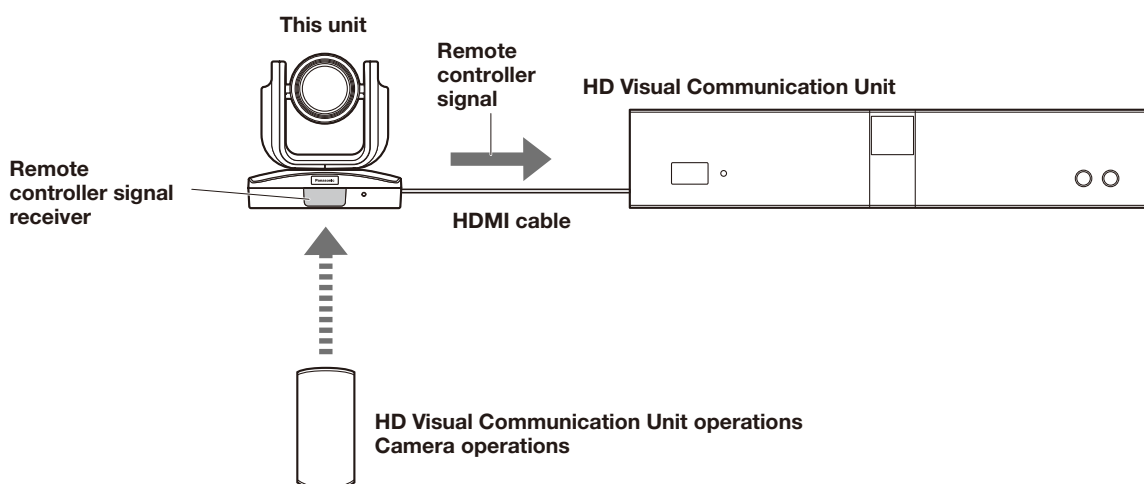

- To turn on the remote control through function, you must perform the settings for the HD Visual Communication Unit. For details on how to select the settings, refer to the operating instructions of the HD Visual Communication Unit to be connected.
- When the remote control through function is enabled, the remote control signal receiver of the HD Visual Communication Unit will not receive signals from the remote controller.

Parts and their functions

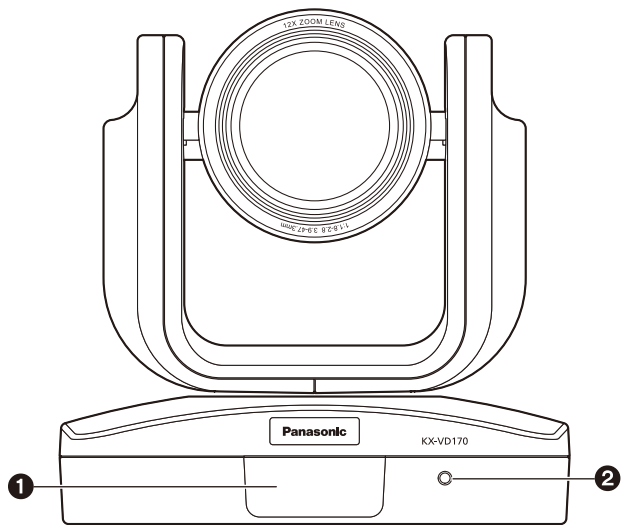

<Rear panel>

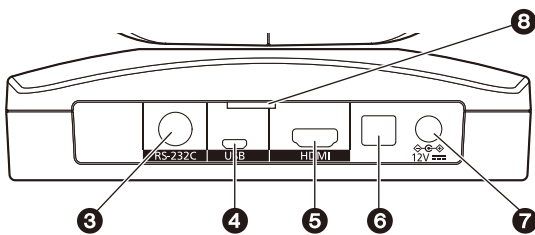

<Side panel>

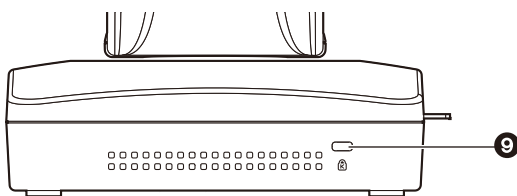

<Bottom panel>

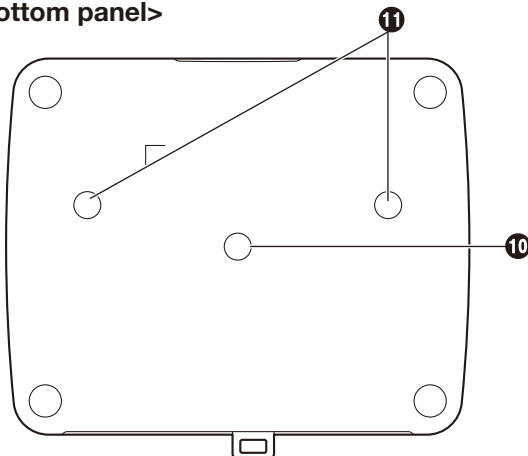

❶ Remote controller signal receiver

Used when the remote control through function (page 12) is used.

❷ Status display lamp

This lights in the following way depending on the status of the unit.

Orange: Standby mode (page 16)

Green: Power ON mode (page 16)

Red: When trouble has occurred in the unit

Green and blinks twice: When signals from the remote controller are received

❸ RS-232C port [RS-232C]

Not used.

❹ USB port [USB]

Not normally used. This port is for service purposes only.

❺ HDMI connector [HDMI]

This is the HDMI video output connector.

❻ Setup switch

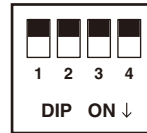

Switches 3 and 4: Always set these switches to the "OFF" position when using the unit. Setting the switches to "ON" may cause the remote controller stop responding and also result in other malfunctions. If you accidentally set the switches to the "ON" position, move them back to the "OFF" position, and turn off and on the camera's power.

	Function	OFF	ON	Factory setting
1	The image is flipped vertically	The image is not flipped	The image is flipped	OFF
2	The image is flipped horizontally	The image is not flipped	The image is flipped	OFF
3	Unused	—	—	OFF
4	Unused	—	—	OFF

❼ DC IN connector [⚡ 12V ⚡]

Connect the DC cord of the dedicated AC adaptor.

IMPORTANT

- Use of an AC adaptor other than the dedicated one may lead to unsafe operation. Be sure to use the dedicated AC adaptor.

❸ Drop-prevention wire mounting hole

Use this hole to attach the drop-prevention wire supplied with the KX-VCZ170 (separately sold).

Refer to the operating instructions supplied with the KX-VCZ170 for more details.

❹ Anti-theft wire mounting hole

Use this hole to attach the anti-theft wire bracket (commercially available).

❷❶ Threaded hole (thread: 1/4-20UNC) for mounting the camera

Use the hole ❷ when mounting the camera on a tripod, etc. When using a Ceiling Mount Bracket which is sold separately (KX-VCZ170), use the holes ❷ and ❶.

Stand-alone installation procedure

Note

- A protective cap is attached to the camera lens. When the installation has finished, remove the protective cap.

■ When installing the unit on a desk

Place the unit flat on the surface.

Notes

- Install the unit in a stable location which will not be susceptible to shaking. If the unit is installed in a location which is susceptible to shaking, this will cause the unit's images to shake in turn.
- Take care not to allow the unit to fall or otherwise be damaged during installation.
- When carrying the unit, do not hold it by its head.
- Do not take hold of the camera head or rotate it. Doing so may cause malfunctioning.
- Take care not to pull the connected cables. Doing so may cause the unit to fall and/or it may result in injury.

Ensure that the unit will not fall off.

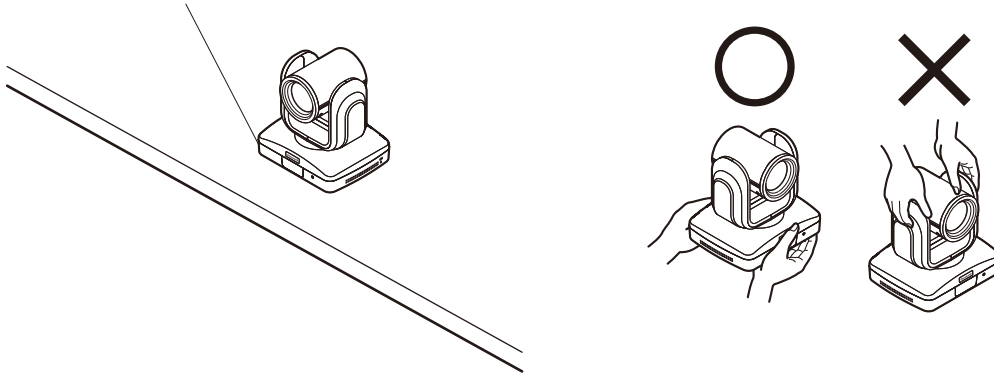

■ When mounting the unit on a tripod

Use a highly stable tripod which can bear the weight of the camera mounted on it.

Attach the tripod to the threaded hole for mounting the camera (10 on page 13) at the center of the camera's bottom panel.

Place the tripod on a completely flat and level surface.

Tighten the screw by hand to mount the tripod securely.

Do not tighten the screw by rotating the camera body. Doing so may cause malfunctioning.

Use screw for mounting the tripod that satisfy the following standard.

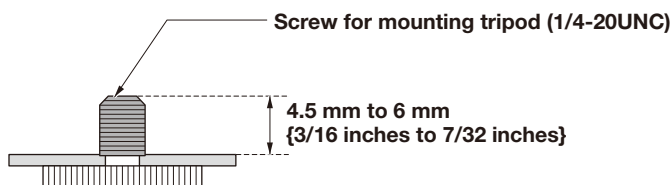

Notes

- Do not install the unit where people will be passing back and forth.
- When using the unit mounted on a tripod, do not put the tripod high above the floor level.
- Mount the unit securely so there is no looseness. Looseness may cause the unit to fall off and/or result in injuries.
- When the unit is going to be used for a prolonged period of time, take steps to ensure that the unit will not topple or fall over and that it will not fall off or fall down. After using the unit, restore the installation location to its original state without delay.

Connections

■ Connections to the HD Visual Communication Unit and AC adaptor

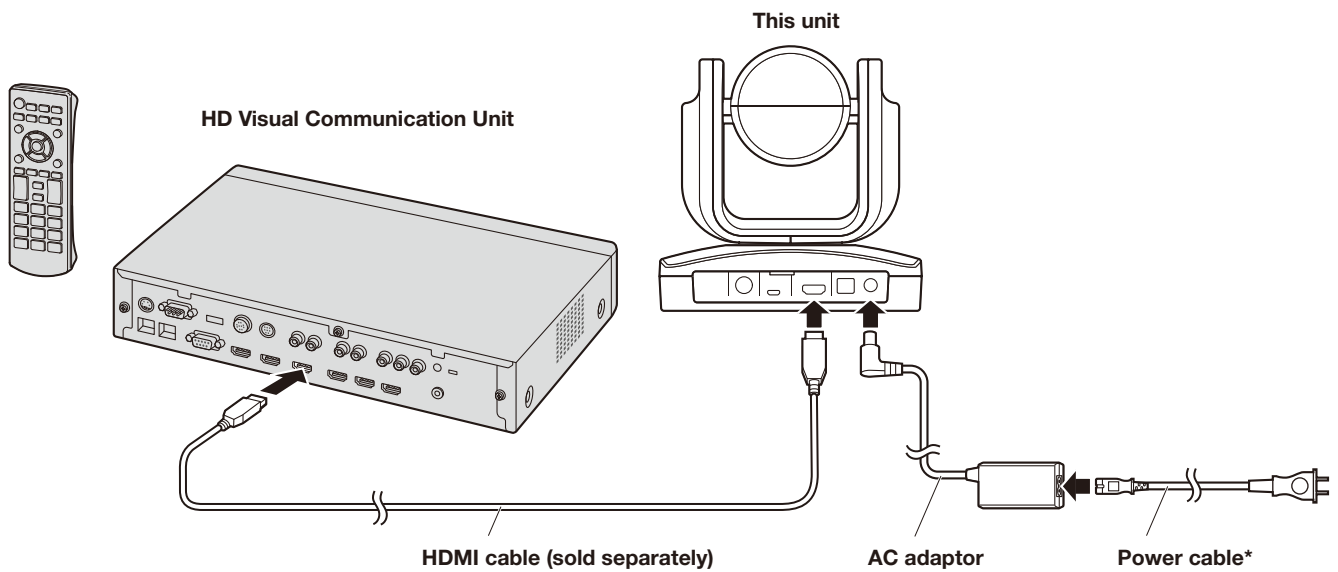

* Use the power cable that is suited to your locality.

- For details on how to operate the unit and select its settings, refer to the operating instructions of the HD Visual Communication Unit to be connected.
- If necessary, turn on the setup switches on the rear side of the unit.
Setup examples) Stand-alone installation: Switch 1 = OFF; Switch 2 = OFF
Suspended installation: Switch 1 = ON; Switch 2 = ON
- Prepare the following commercially available cables:
HDMI cable: Category 2 (high speed) recommended

Note

- Use cables with the HDMI logo (certified HDMI cables) for HDMI connection. Using non-certified cables may adversely affect operation. Use HDMI cables with secure connectors.

How to turn the power on and off

■ Turning the power on

- This unit does not have a power switch. Its power is turned on when power is supplied to the unit.



- The camera moves so that it is positioned at the home position.

■ Turning the power off

- When the supply of power to the unit is cut off, the unit's power is turned off.
The power can be turned off regardless of the unit's mode (standby mode or power ON mode).

■ Concerning the mode transitions

[Description of each mode]

Mode	Status
Standby mode Status display lamp: Orange	When the HD Visual Communication Unit is in one of the statuses described below: <ul style="list-style-type: none"> HD Visual Communication Unit is in screen standby mode.* The camera has not been connected to the HD Visual Communication Unit. The power of the HD Visual Communication Unit is OFF (power LED: red)* * When the administrator menu settings of the HD Visual Communication Unit are used to select [HDMI Settings] followed by [Standby] and then [Standby] is set from [OFF] to [ON], the transition of the status of the camera mode becomes linked with the screen standby status of the unit. For details of the screen standby function, refer to the operating instructions of the HD Visual Communication Unit.
Power ON mode Status display lamp: Green	Status in which the camera has been connected properly to the HD Visual Communication Unit and can be controlled

The transition of the status of the camera mode is linked with the status of the HD Visual Communication Unit. The camera, however, does not transition to standby mode when the AC power of the HD Visual Communication Unit is OFF (power LED: off).

[Linkage with the screen standby status of the HD Visual Communication Unit]

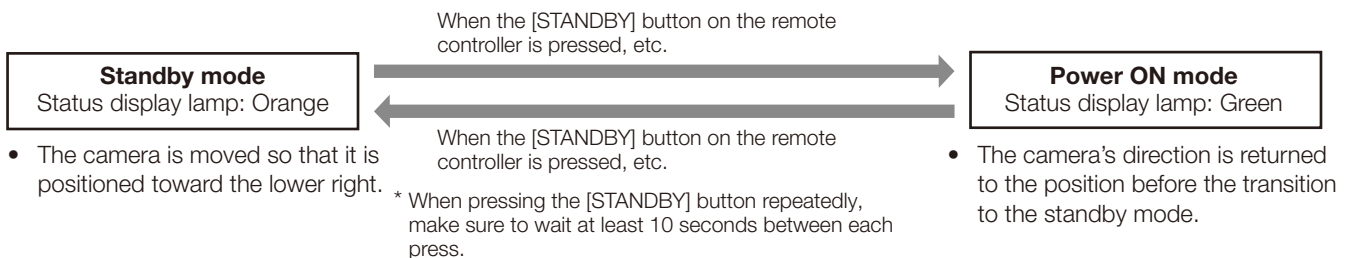

[Linkage with the status of the connection with the HD Visual Communication Unit]

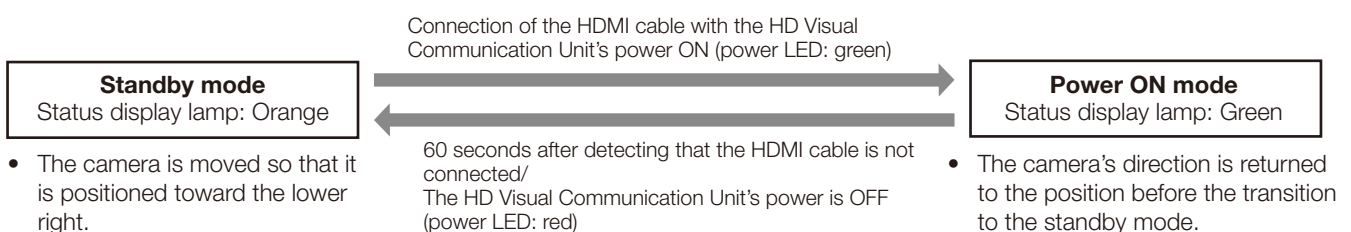

Factory setting

■ Factory settings for the setting items

Item	Factory setting
Brightness	Auto
White Balance	Auto
Focus	Focus Mode: Auto
Backlight	OFF
Flicker	OFF
Digital Zoom	OFF
Sharpness	Medium
Noise Filter	Low
Preset number 1-12	Pan/Tilt Position: Center Brightness: Auto White Balance: Auto
Home Position*	Fixed at preset number 5

* The camera moves to this position first when its power is turned on.

- For details on how to operate the unit and select its settings, refer to the operating instructions of the HD Visual Communication Unit to be connected.

Troubleshooting

● Operation

Symptom	Cause and remedial action	Reference pages
No power	<ul style="list-style-type: none"> • Is the power plug securely connected to the AC outlet? 	—
	<ul style="list-style-type: none"> • Are the AC adaptor and the power cable connected properly? 	P.15
Cannot operate (common to wireless remote controller, HD Visual Communication Unit)	<ul style="list-style-type: none"> • Is the power on? → If the unit's status display lamp is off, it means that the unit's power is not being supplied. 	P.16
	<ul style="list-style-type: none"> • Has the camera been selected correctly from the HD Visual Communication Unit? 	Operating instructions of the HD Visual Communication Unit: [Controlling a Video Camera] > [Controlling a Video Camera]
Cannot perform operations with the remote controller using the remote control through function	<ul style="list-style-type: none"> • Have the remote control's batteries run down or have the batteries been installed with their polarities reversed? → If the status display lamp does not blink even when the remote controller is operated near the remote controller signal receiver, it means that the batteries have run down. Replace the batteries. 	Operating instructions of the HD Visual Communication Unit: [Miscellaneous] > [Changing the Remote Control Batteries]
	<ul style="list-style-type: none"> • Is there a fluorescent light or plasma monitor near the unit and, if so, is the remote controller signal receiver exposed to its light? 	—
	<ul style="list-style-type: none"> • Did you set the remote controller signal receiver of the camera to "ON" using the HD Visual Communication Unit setting? 	Operating instructions of the HD Visual Communication Unit: [Contacts and Settings] > [Changing System Settings/Performing System Maintenance] > [Changing Video Camera Settings]
Camera is out of alignment with the preset positions	<ul style="list-style-type: none"> • The camera may not be in alignment with the preset position if its position was forcibly moved by hand while images were being displayed. → Turn the camera's power off and then back on. 	P.16
The status display lamp has lighted up in red	<ul style="list-style-type: none"> • Trouble has occurred in the camera. → Turn the camera's power off and then back on. 	P.13 P.16

Troubleshooting

● Video

Symptom	Cause and remedial action	Reference pages
No pictures are displayed or the pictures are disturbed	<ul style="list-style-type: none"> • Has the unit been connected properly to the HD Visual Communication Unit? 	P.15
	<ul style="list-style-type: none"> • Has the camera been selected correctly from the HD Visual Communication Unit? 	Operating instructions of the HD Visual Communication Unit: [Controlling a Video Camera] > [Controlling a Video Camera]
No auto focusing	<ul style="list-style-type: none"> • Is the focus set to manual? → Auto focusing is initiated as soon as the focus is set to auto. 	Operating instructions of the HD Visual Communication Unit: [Controlling a Video Camera] > [Changing Video Camera Settings]
	<ul style="list-style-type: none"> • In some situations, it may be hard to focus at the auto setting. (Example: A background with a complex pattern, such as a checked pattern, may be brought into focus.) → Select the manual setting, and focus manually. 	
The subject is not brought into focus during zooming when the manual setting is used for the focus	<ul style="list-style-type: none"> • Was the focus adjusted at the Tele end? → First adjust the focus at the Tele end where the focusing accuracy is higher, and then proceed with the zooming. 	Operating instructions of the HD Visual Communication Unit: [Controlling a Video Camera] > [Changing Video Camera Settings]
	<ul style="list-style-type: none"> • Under some operating conditions, it may be hard to bring subjects into focus. → Use the focus at the auto setting. 	
Something is wrong with the coloring of the pictures	<ul style="list-style-type: none"> • Activate the automatic white balance setting (auto tracking white adjustment) function. 	Operating instructions of the HD Visual Communication Unit: [Controlling a Video Camera] > [Changing Video Camera Settings]
	<ul style="list-style-type: none"> • In some situations, the proper colors may not be reproduced using the automatic white balance setting function. → Adjust the white balance manually. 	

Troubleshooting

Symptom	Cause and remedial action	Reference pages
The pictures are too light or too dark	<ul style="list-style-type: none"> Adjust the brightness manually. 	Operating instructions of the HD Visual Communication Unit: [Controlling a Video Camera] > [Changing Video Camera Settings]
The subjects appear distorted	<ul style="list-style-type: none"> If a subject has suddenly crossed in front of the camera, it may appear slightly distorted because this camera uses a CMOS image sensor. This is normal and not indicative of any problem. 	—
	<ul style="list-style-type: none"> The subjects sometimes appear distorted owing to the characteristics of the wide-angle lens used. This is normal and not indicative of any problem. 	—
When the flash is fired during shooting, only the top or bottom of the screen becomes lighter	<ul style="list-style-type: none"> With a CMOS image sensor, the shooting timing differs slightly between the top left and bottom right of the screen. This means that when the flash is fired, the bottom of the screen will become lighter in the field concerned and the top will become lighter in the next field. This is normal and not indicative of any problem. 	—
When fine lines or cyclical patterns are shot, flickering is seen or coloring is added to them	<ul style="list-style-type: none"> This phenomenon occurs because the pixels are arranged systematically on each image sensor. It is noticeable when the spatial frequency of a subject and the pixel pitch are brought into proximity so change the camera angle or take other such action. 	—
The image is flipped horizontally or turned upside down.	<ul style="list-style-type: none"> Are the setup switches on the rear side of the unit set to the correct positions? → Set the setup switches to the correct positions. 	P.13 P.15

Specifications

■ GENERAL

Ambient operating temperature:	0 °C to +40 °C {+32 °F to +104 °F}
Storage temperature:	-20 °C to +50 °C {-4 °F to +122 °F}
Allowable humidity ranges:	20 % to 90 % (no condensation)
Mass:	Approx. 1.6 kg {3.53 lbs.}
Dimensions (W × D × H):	180 mm × 145 mm (excluding the projections) × 184 mm {7-3/32 inches × 5-23/32 inches × 7-1/4 inches}
Finish:	Silver

■ INPUT

Input connector:	DC 12 V IN
-------------------------	------------

■ OUTPUT

Video output:	HDMI (HDMI connector)
----------------------	-----------------------

■ FUNCTIONS AND PERFORMANCE

[Camera unit]	
Imaging sensors:	1/2.8-type Full-HD CMOS
Lens:	Motorized 12× zoom, F1.8 to 2.8 (f=3.9 mm to 47.3 mm {5/32 inches to 1-7/8 inches}) 10× digital zoom
Focus:	Switching between auto and manual
Focus distance:	Tele end: 1.5 m {4.92 feet} Wide end: 1 m {3.3 feet}
Field of view:	Horizontal 72.5° (Wide) – 6.3° (Tele)
Horizontal resolution:	900 TV lines Typ (Center area, Wide)
White balance function:	Provided
Output format:	HD 1080: 60p HD 1080: 50p

[Pan-tilt head unit]

Pan/tilt operation speed:	Max. 90°/s or more
Panning range:	±130°
Tilting range:	+90°/-25°
Quietness:	NC35 (normal speed), NC40 (when preset)

■ AC adaptor

[PNLV6508]	
Mass:	Approx. 180 g {0.40 lbs.}
Input:	AC 100 V to 240 V, 0.5 A to 0.3 A, 50 Hz/60 Hz
Output:	DC 12 V, 1.5 A

■ Optional accessory

Ceiling Mount Bracket	KX-VCZ170
-----------------------	-----------

Mass and dimensions shown are approximate.
Specifications are subject to change without notice.

Panasonic Corporation

<http://www.panasonic.com>

Panasonic Corporation
Osaka, Japan

Authorised Representative in EU:

Panasonic Testing Centre
Panasonic Marketing Europe GmbH
Winsbergring 15, 22525 Hamburg, Germany

